

SAPPHIRE

BESPOKE SOLUTIONS FOR ALUMINIUM

PARTITION SUITES

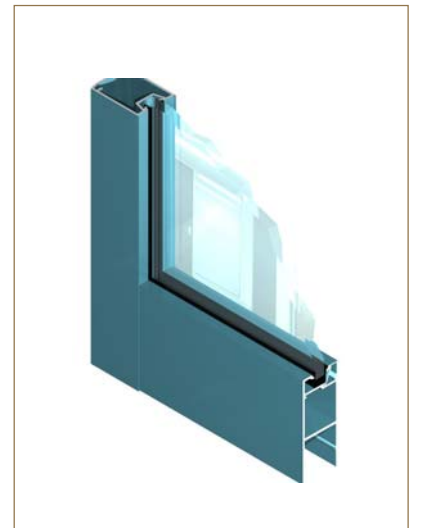
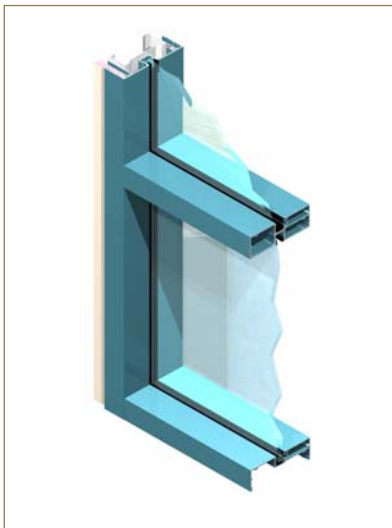
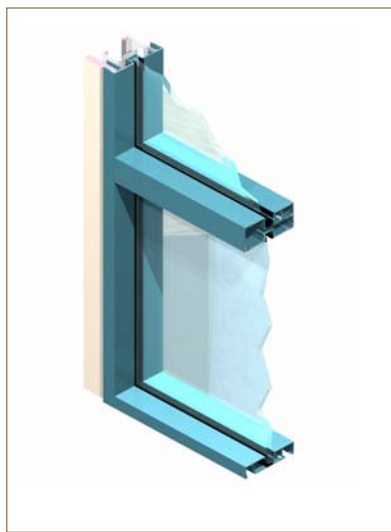

OVERVIEW - 19.9 SA

sapal.com.au

FLEXIBILITY

Partitions are built on site allowing minor changes to design and layout to be easily accommodated with **NO EXTRA COST AND NO PROJECT DELAY** that comes from factory assembled systems.

TAILOR MADE

With so many profiles and interlocking shapes, Sapphire partitions can be configured in so many unique ways. This is a product that will excite any architect / designer.

COMPETITIVE PRICE

Sapphire partition frames can be used with standard drywall. Plasterboard, steel stud frames, glass and timber doors can be sourced locally. This ensures that Sapphire partitions are very price competitive.

EXCITING ANODISED FINISHES

Sapphire partition frames are constructed with anodised aluminium profiles. We have an outstanding range of anodised colours that can be used to compliment any design. (Refer to our website)

Anodising is the most durable and beautiful finish that can be applied to aluminium as it highlights and enhances the natural characteristics of aluminium.

SUPERFAST LEADTIME

Sapphire strives to deliver all standard sections within two to three weeks regardless of finish. (NB : for export markets customs procedures may delay delivery in some countries). Sapphire will ensure that challenging project schedules will not be compromised.

COMPLIANCE WITH BCA

Sapphire Partition Systems are designed to comply with Building Code of Australia (BCA) and in particular to AS1428.1-2009 and AS1288-2006 ensuring your fitout will comply with the relevant codes.

SPEEDY INSTALLATION

Sapphire aluminium is prefinished so that no touch up is required after installation. All necessary accessories are supplied as part of the system. Aluminium is light and easy to cut on site. Snap together profiles reduce construction and on site labour costs.

BEING GREEN

When you specify/purchase Sapphire partitions you are taking care of the environment as our products are made from recycled and primary aluminium. Combining this with an anodised finish you have a product that is 100% recyclable and free of harmful VOC's.

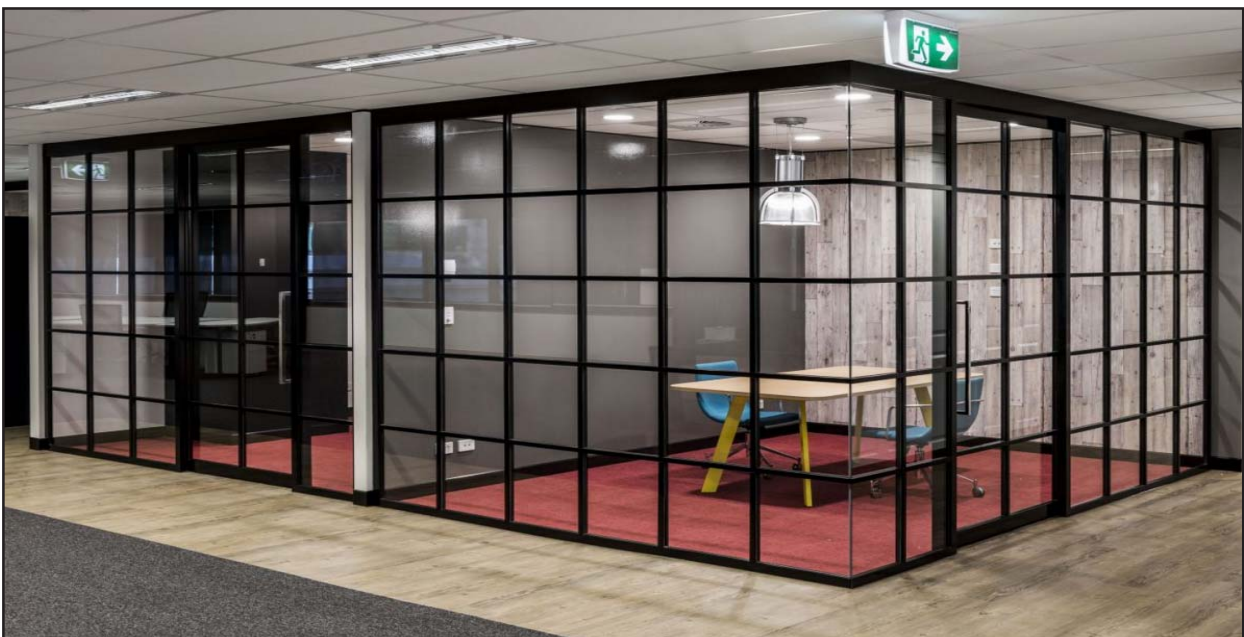

SAPPHIRE

BESPOKE SOLUTIONS FOR ALUMINIUM

MICROLINE®

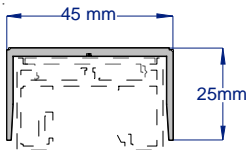

SAP102
DEFLECTION HEAD / WALL STARTER
2.8 & 3.6 METRE LENGTHS

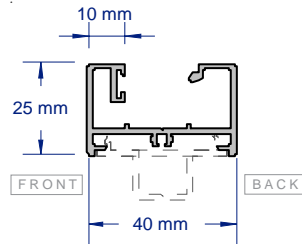

SAP103
GLAZING FRAME
2.8 & 3.6 METRE LENGTHS

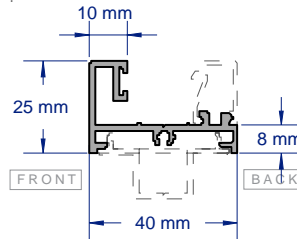

SAP104
GLAZING SILL
2.8 & 3.6 METRE LENGTHS

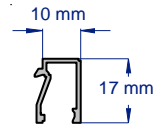

SAP105
GLAZING BEAD
2.8 & 3.6 METRE LENGTHS

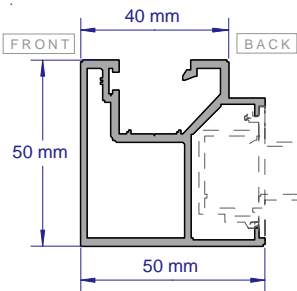

SAP106
50MM CORNER POST
2.8 & 3.6 METRE LENGTHS

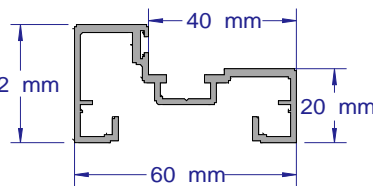

SAP107
35MM DOORFRAME
2.8 & 3.6 METRE LENGTHS

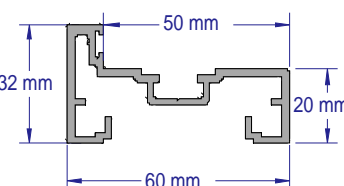

SAP108
45MM DOORFRAME
2.8 & 3.6 METRE LENGTHS

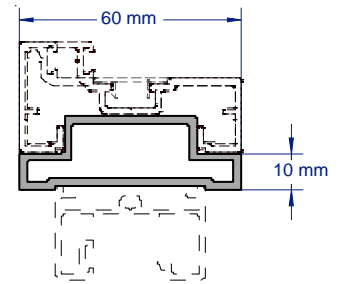

SAP109
ELECTRIC STRIKE ADAPTOR
2.8 & 3.6 METRE LENGTHS

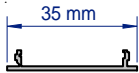

SAP111
FLAT SNAPIN
2.8 & 3.6 METRE LENGTHS

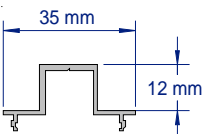

SAP111C
SHADOWLINE SNAPIN
2.8 & 3.6 METRE LENGTHS

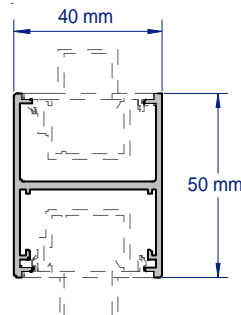

SAP113
50MM MULTICAP/WALLSTARTER
2.8 & 3.6 METRE LENGTHS

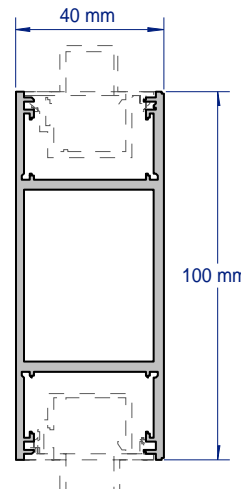

SAP114
100MM MULTICAP/TRANSOM
2.8 & 3.6 METRE LENGTHS

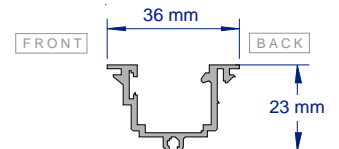

SAP116
GLAZING INFIL
2.8 & 3.6 METRE LENGTHS
NEW VERSION AVAILABLE FROM 01/07/2017, OLD
VERSION IS SAP116A

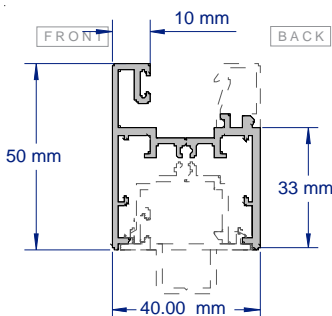

SAP119
50MM TRANSOM/SILL
2.8 & 3.6 METRE LENGTHS
NEW VERSION AVAILABLE FROM 01/07/2017, OLD
VERSION IS SAP119A

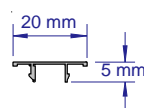

SAPC20
COVER CAP
2.8 & 3.6 METRE LENGTHS

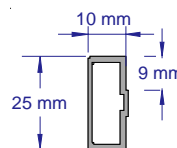

SAP25T
25MM STICK ON MULLION / TRANSOM TRIM
2.8 & 3.6 METRE LENGTHS

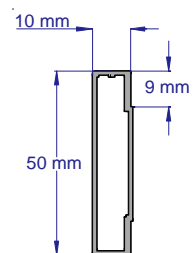

SAP50T
50MM STICK ON MULLION / TRANSOM TRIM
2.8 & 3.6 METRE LENGTHS

ISSUE NO 19.9

DATE : 01/09/2019
REPLACES : 01/07/2017
SUBJECT TO CHANGE WITHOUT NOTICE

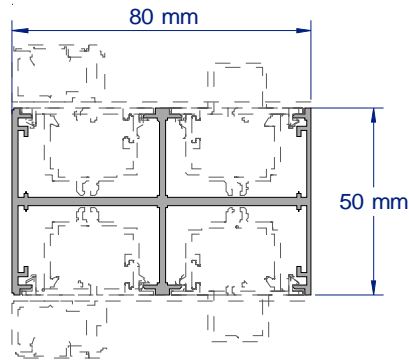

SAP130

80MM MULTICAP/WALLSTARTER/DOORFRAME - SINGLE/DOUBLE GLAZE
2.8 & 3.6 METRE LENGTHS

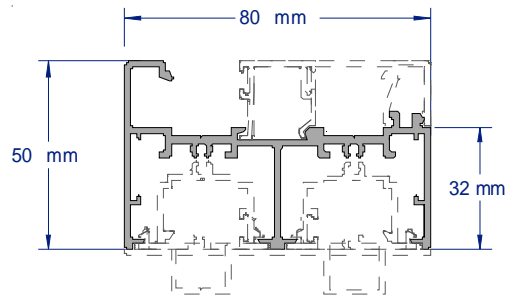

SAP140

80MM TRANSOM/SILL - SINGLE/DOUBLE GLAZE
2.8 & 3.6 METRE LENGTHS

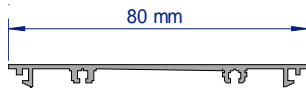

SAP131

80MM FLAT SNAPIN
2.8 & 3.6 METRE LENGTHS

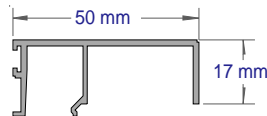

SAP139

80MM SINGLE GLAZE BEAD
2.8 & 3.6 METRE LENGTHS

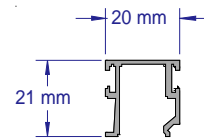

SAP143

80MM DOUBLE GLAZE CAP
2.8 & 3.6 METRE LENGTHS

MISCELLANEOUS

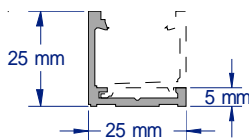

SAP044

25MM GLAZING FRAME
2.8 & 3.6 METRE LENGTHS

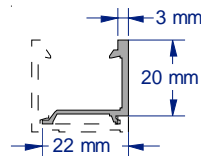

SAP045

25MM GLAZING BEAD
2.8 & 3.6 METRE LENGTHS

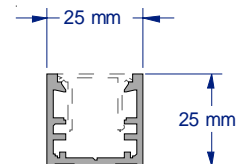

SAP047

GLAZING CHANNEL
2.8 & 3.6 METRE LENGTHS

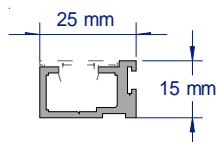

SAP046

ACOUSTIC DOORSTOP
2.8 & 3.6 METRE LENGTHS

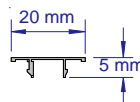

SAPC20

ACOUSTIC SNAP IN COVER
2.8 & 3.6 METRE LENGTHS

SAPPHIRE

BESPOKE SOLUTIONS FOR ALUMINIUM

WIDELINE® GEN 2

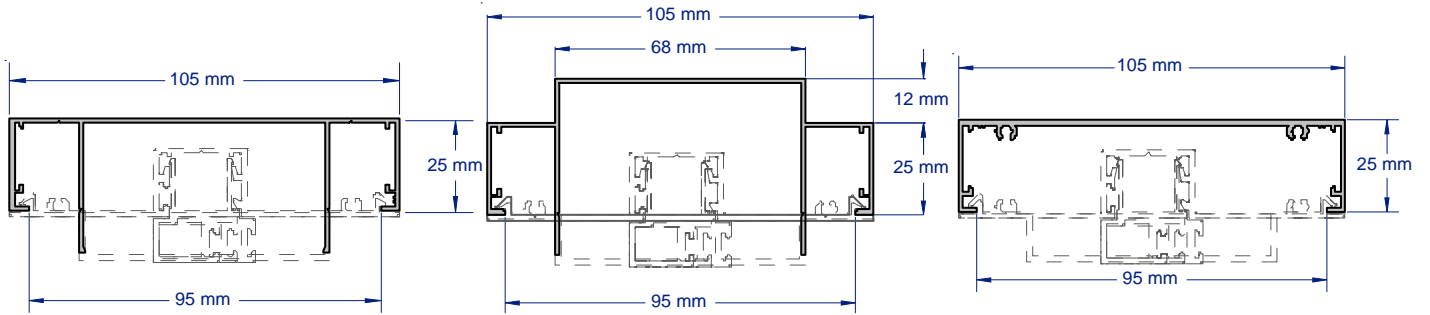

SAP010

25MM CAPPING HEAD / FRAME
2.8 & 3.6 METRE LENGTHS

SAP010C

25MM SHADOWLINE CAPPING HEAD / FRAME
2.8 & 3.6 METRE LENGTHS

SAP012

25MM CAPPING HEAD / WALLSTARTER
2.8 & 3.6 METRE LENGTHS

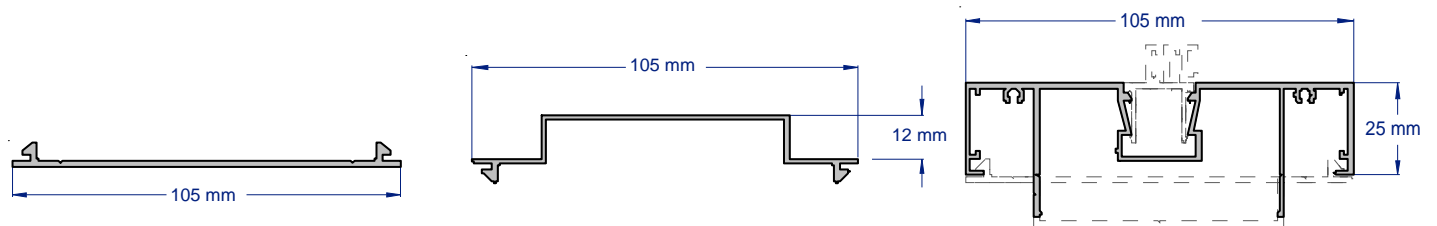

SAP011

SNAP IN FLUSH ADAPTOR
2.8 & 3.6 METRE LENGTHS

SAP011C

SNAP IN SHADOWLINE ADAPTOR
2.8 & 3.6 METRE LENGTHS

SAP014A

25MM PLASTERBOARD POCKET FRAME
2.8 & 3.6 METRE LENGTHS

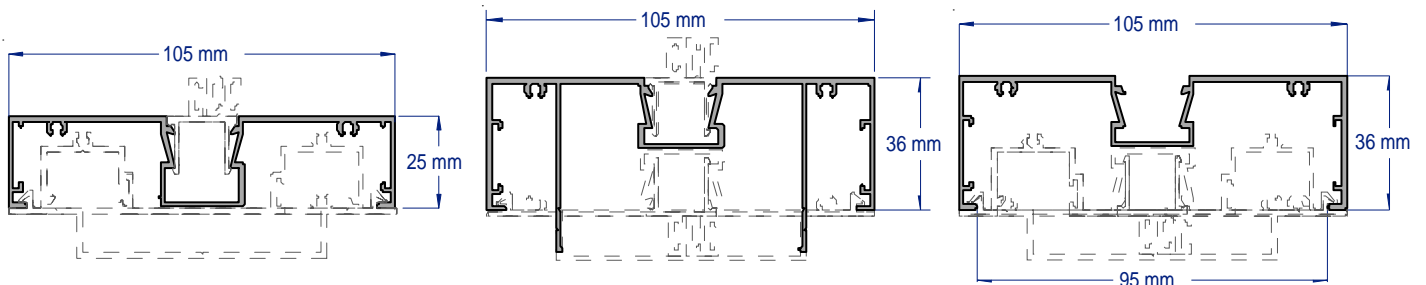

SAP014GA

25MM POCKET FRAME
2.8 & 3.6 METRE LENGTHS

SAP014MA

36MM PLASTERBOARD POCKET FRAME
2.8 & 3.6 METRE LENGTHS

SAP015A

36MM POCKET CAPPING / FRAME
2.8 & 3.6 METRE LENGTHS

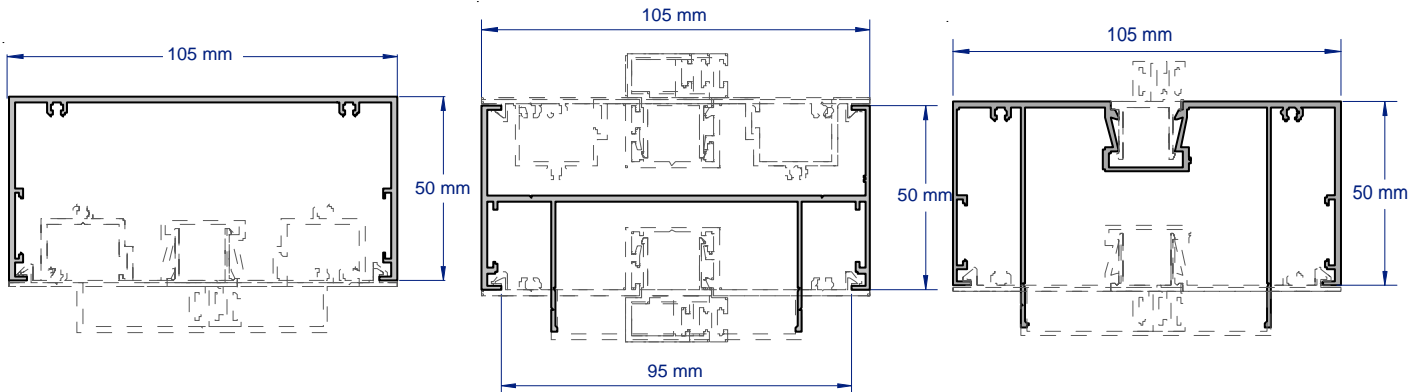

SAP012L

50MM CAPPING HEAD / WALLSTARTER
COMPLIES WITH AS1428.1 2009
2.8 & 3.6 METRE LENGTHS

SAP013L

50MM CAPPING HEAD / FRAME
COMPLIES WITH AS1428.1 2009
2.8 & 3.6 METRE LENGTHS

SAP014FA

50MM PLASTERBOARD POCKET FRAME
COMPLIES WITH AS1428.1 2009
2.8 & 3.6 METRE LENGTHS

PLEASE NOTE ! WIDELINE GEN 2 IS ONLY AVAILABLE IN SA , ALL OTHER STATES USE GEN 3

ISSUE NO 19.9

DATE : 01/09/2019

REPLACES : 01/07/2017

SUBJECT TO CHANGE WITHOUT NOTICE

SAPPHIRE

BESPOKE SOLUTIONS FOR ALUMINIUM

WIDELINE® GEN 2

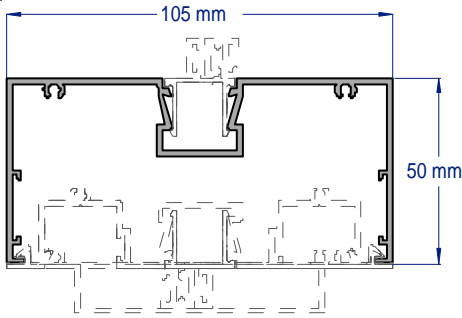

SAP014LA

50MM POCKET CAPPING / FRAME
COMPLIES WITH AS1428.1 2009
2.8 & 3.6 METRE LENGTHS

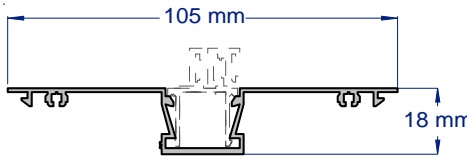

SAP016A

SNAP IN POCKET GLAZE
2.8 & 3.6 METRE LENGTHS

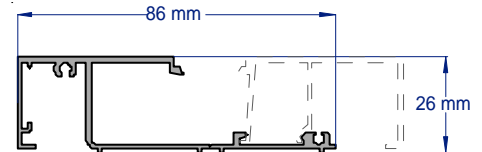

SAP019A

25MM SILL
2.8 & 3.6 METRE LENGTHS

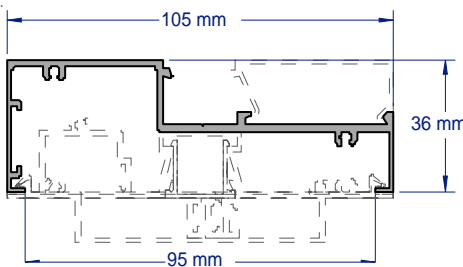

SAP019MA

36MM SILL/TRANSOM
2.8 & 3.6 METRE LENGTHS

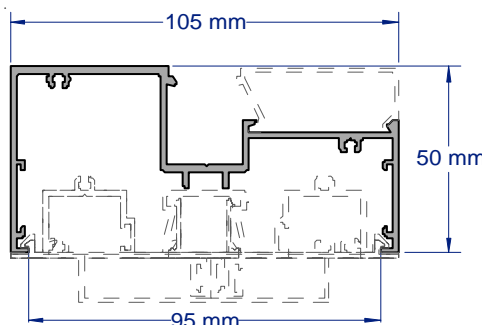

SAP019LA

50MM SILL/TRANSOM
2.8 & 3.6 METRE LENGTHS

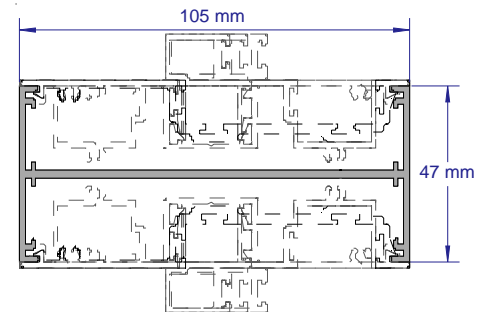

SAP021

50MM MULTICAP
COMPLIES WITH AS1428.1 2009
2.8 & 3.6 METRE LENGTHS (NEW)

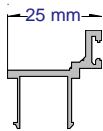

SAP017-35

35MM DOORSTOP

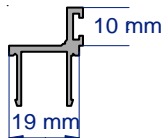

SAP017

40MM DOORSTOP

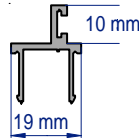

SAP018B

45MM DOORSTOP

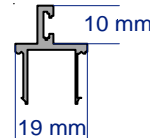

SAP018A

50MM DOORSTOP

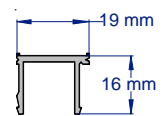

SAP023

POCKET INFIL
2.8 & 3.6 METRE LENGTHS

PLEASE NOTE! DOOR STOP THICKNESS STATED ALLOWS FOR A ZERO SETBACK FROM THE EDGE OF THE FRAME WHEN DOOR IS HUNG 2.8 & 3.6 METRE LENGTHS

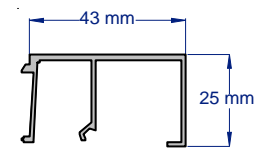

SAP020

25MM SILL BEAD
2.8 & 3.6 METRE LENGTHS

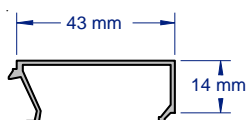

SAP022

SILL/TRANSOM BEAD
2.8 & 3.6 METRE LENGTHS

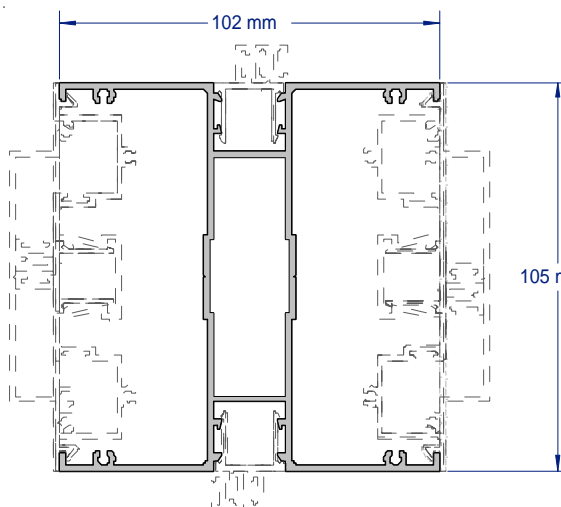

SAP024

4 WAY CORNER POST
COMPLIES WITH AS1428.1 2009
2.8 & 3.6 METRE LENGTHS

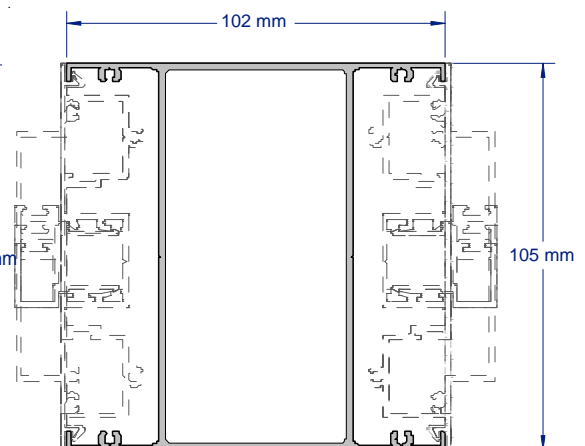

SAP024D

2 WAY POST
COMPLIES WITH AS1428.1 2009
2.8 & 3.6 METRE LENGTHS

PLEASE NOTE! WIDELINE GEN 2 IS ONLY AVAILABLE IN SA, ALL OTHER STATES USE GEN 3

ISSUE NO 19.9

DATE : 01/09/2019

REPLACES : 01/07/2017

SUBJECT TO CHANGE WITHOUT NOTICE

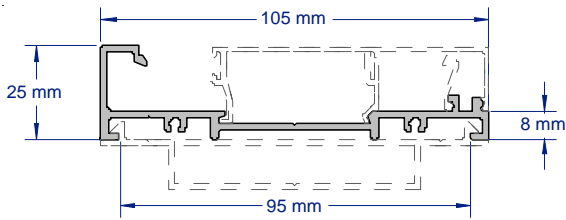

SAP033
25MM FRONT/DOUBLE GLAZING SILL
2.8 & 3.6 METRE LENGTHS

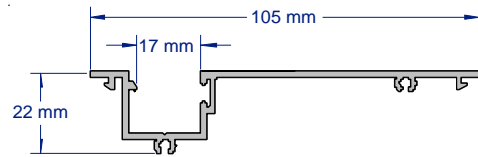

SAP038
GLAZING SNAP IN
2.8 & 3.6 METRE LENGTHS

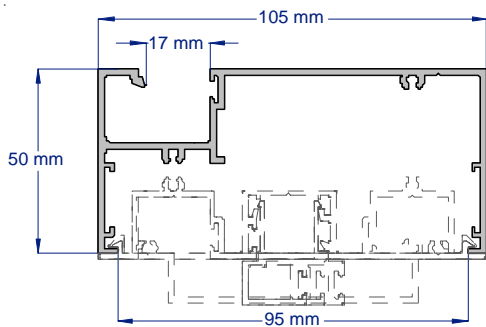

SAP037
50MM GLAZING FRAME/MULLION
COMPLIES WITH AS1428.1 2009
2.8 & 3.6 METRE LENGTHS

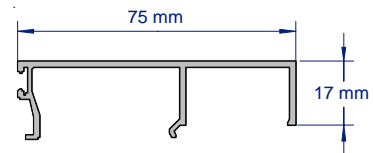

SAP039
50MM FRONT GLAZE BEAD TO SUIT
SAP033, SAP040
2.8 & 3.6 METRE LENGTHS

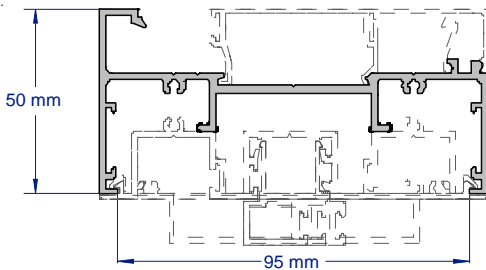

SAP040
50MM FRONT/DOUBLE GLAZE SILL/TRANSOM
COMPLIES WITH AS1428.1 2009
2.8 & 3.6 METRE LENGTHS

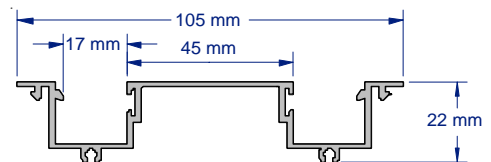

SAP041
DOUBLE GLAZING SNAP IN
COMPLIES WITH AS1428.1 2009
2.8 & 3.6 METRE LENGTHS

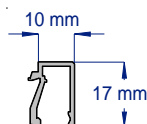

SAP105
GLAZING BEAD
2.8 & 3.6 METRE LENGTHS

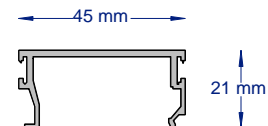

SAP043
DOUBLE GLAZE CAP TO SUIT SAP033, SAP040
2.8 & 3.6 METRE LENGTHS

SAPPHIRE

BESPOKE SOLUTIONS FOR ALUMINIUM

76MM MAXLINE® GEN 2

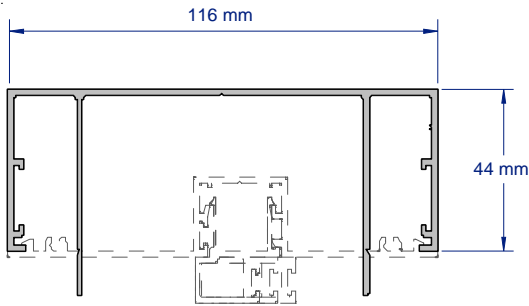

SAP210L

45MM CAPPING HEAD / WALLSTARTER
COMPLIES WITH AS1428.1 2009
2.8 & 3.6 METRE LENGTHS

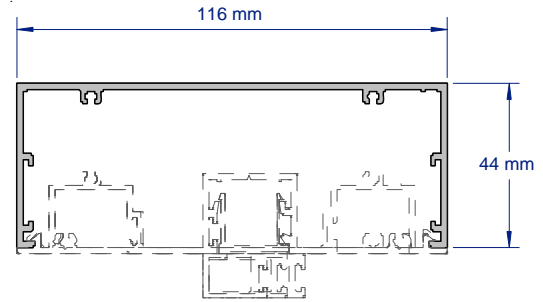

SAP212L

45MM CAPPING HEAD / FRAME
COMPLIES WITH AS1428.1 2009
2.8 & 3.6 METRE LENGTHS

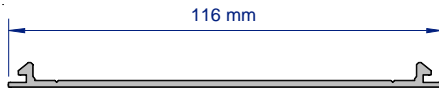

SAP211

SNAP IN FLUSH ADAPTOR
2.8 & 3.6 METRE LENGTHS
116 mm

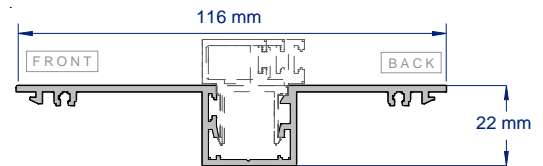

SAP216

SNAP IN POCKET GLAZE
2.8 & 3.6 METRE LENGTHS

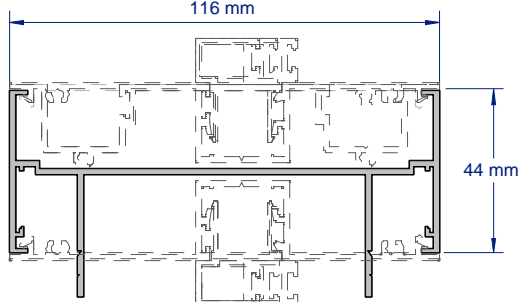

SAP213

45MM CAPPING HEAD / FRAME STARTER
COMPLIES WITH AS1428.1 2009
2.8 & 3.6 METRE LENGTHS

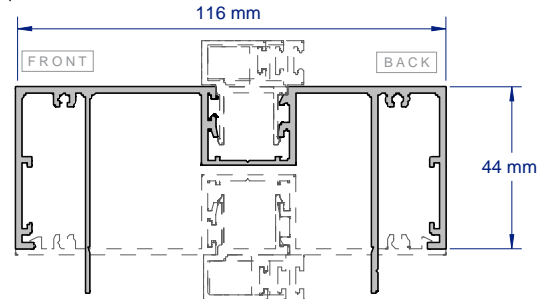

SAP214L

45MM PLASTERBOARD POCKET FRAME
COMPLIES WITH AS1428.1 2009
2.8 & 3.6 METRE LENGTHS

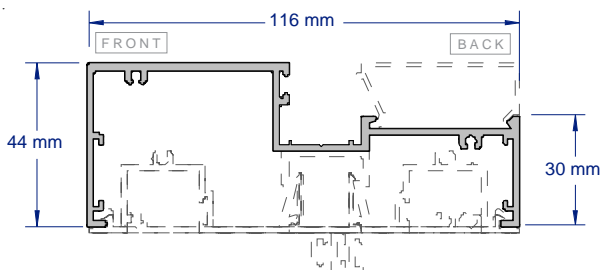

SAP219L

45MM SILL/TRANSOM
2.8 & 3.6 METRE LENGTHS

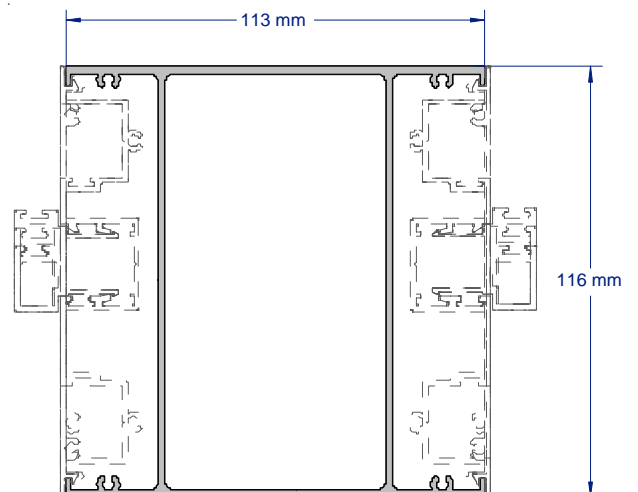

SAP224D

2 WAY POST
COMPLIES WITH AS1428.1 2009
2.8 & 3.6 METRE LENGTHS

ISSUE NO 19.9
DATE : 01/09/2019
REPLACES : 01/07/2017
SUBJECT TO CHANGE WITHOUT NOTICE

SAPPHIRE

BESPOKE SOLUTIONS FOR ALUMINIUM

76 MM MAXLINE® GEN 2

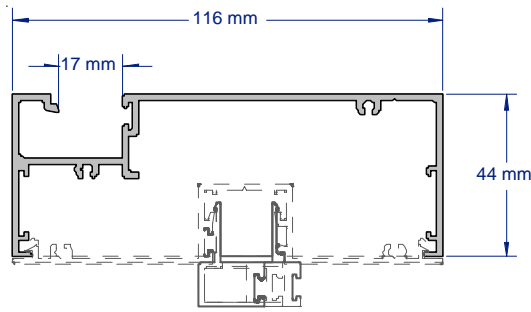

SAP237

FRONT GLAZE FRAME / MULLION
COMPLIES WITH AS1428.1 2009
2.8 & 3.6 METRE LENGTHS

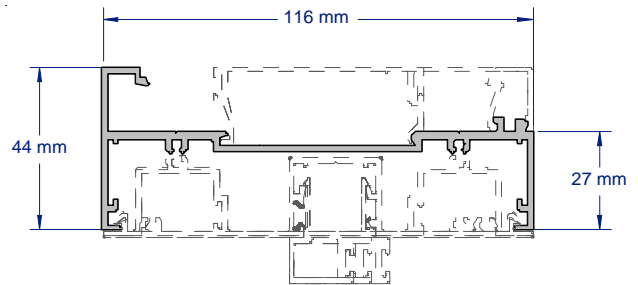

SAP240

DOUBLE GLAZE SILL / MULLION / TRANSOM
COMPLIES WITH AS1428.1 2009
2.8 & 3.6 METRE LENGTHS

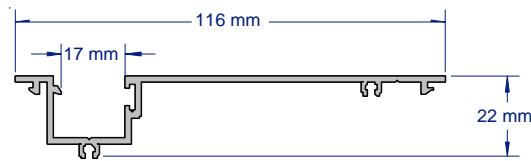

SAP238

FRONT GLAZE SNAPIN
2.8 & 3.6 METRE LENGTHS

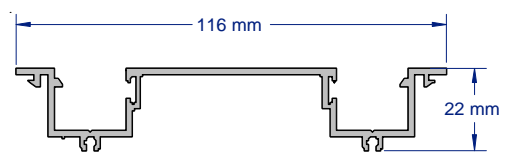

SAP241

DOUBLE GLAZE SNAPIN
2.8 & 3.6 METRE LENGTHS

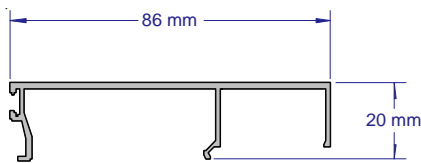

SAP239

FRONT GLAZE SILL BEAD
2.8 & 3.6 METRE LENGTHS

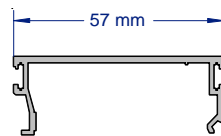

SAP243

DOUBLE GLAZE CAP
2.8 & 3.6 METRE LENGTHS

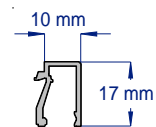

SAP105

GLAZING BEAD
2.8 & 3.6 METRE LENGTHS

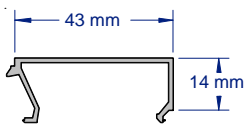

SAP022

SILL/TRANSOM BEAD
2.8 & 3.6 METRE LENGTHS

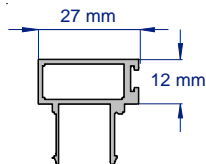

SAPDS35

35MM DOORSTOP (NEW)

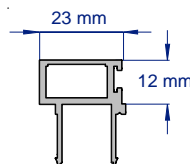

SAPDS40

40MM DOORSTOP (NEW)

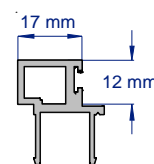

SAPDS45

45MM DOORSTOP (NEW)

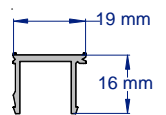

SAPPFI

POCKET FLUSH INFIL (NEW)

PLEASE NOTE! DOOR STOP THICKNESS STATED ALLOWS FOR FLUSH WITH THE EDGE OF THE FRAME WHEN DOOR IS HUNG.
FRAME MUST BE INSTALLED AS SHOWN AS DOORSTOP ONLY SNAPS IN ONE WAY!
AVAILABLE IN 2.8 & 3.6 METRE LENGTHS

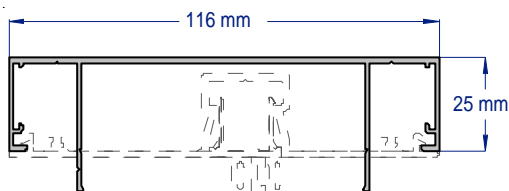

SAP210

116MM CAPPING 25MM
DOES NOT COMPLY WITH AS1428.1 2009
2.8 & 3.6 METRE LENGTHS

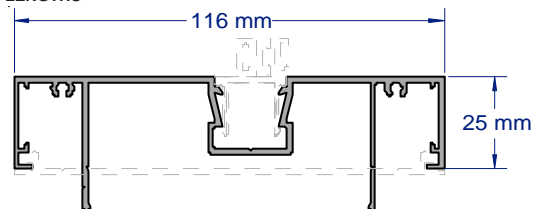

SAP214

116MM MAINFRAME 25MM
DOES NOT COMPLY WITH AS1428.1 2009
2.8 & 3.6 METRE LENGTHS

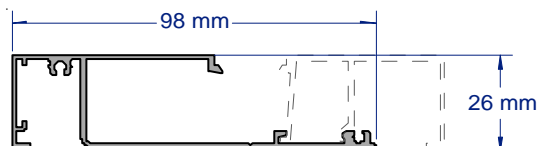

SAP219

116MM GLAZING SILL 25MM
2.8 & 3.6 METRE LENGTHS

ISSUE NO 19.9

DATE : 01/09/2019
REPLACES : 01/07/2017
SUBJECT TO CHANGE WITHOUT NOTICE

SAPPHIRE

BESPOKE SOLUTIONS FOR ALUMINIUM

92MM MAXLINE® GEN 1

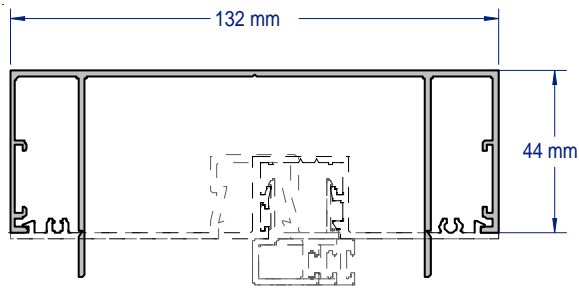

SAP310L
45MM CAPPING HEAD / FRAME
COMPLIES WITH AS1428.1 2009
2.8 & 3.6 METRE LENGTHS

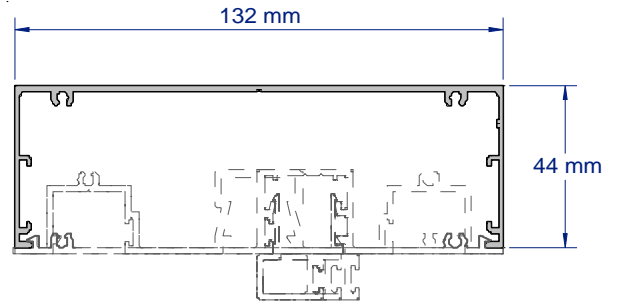

SAP312L
45MM CAPPING / WALLSTARTER
COMPLIES WITH AS1428.1 2009
2.8 & 3.6 METRE LENGTHS



SAP311
SNAP IN FLUSH ADAPTOR
2.8 & 3.6 METRE LENGTHS

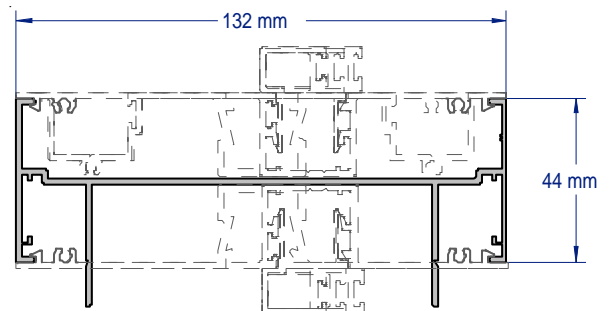

SAP313
45MM MULTI-CAP
COMPLIES WITH AS1428.1 2009
2.8 & 3.6 METRE LENGTHS

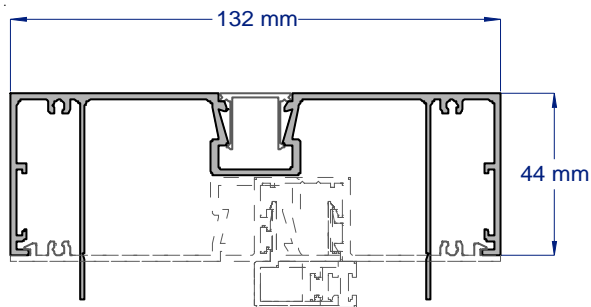

SAP314L
45MM PLASTERBOARD POCKET FRAME
COMPLIES WITH AS1428.1 2009
2.8 & 3.6 METRE LENGTHS

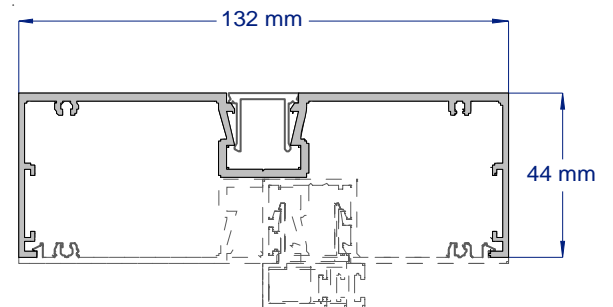

SAP315
45MM PLASTERBOARD POCKET FRAME
COMPLIES WITH AS1428.1 2009
2.8 & 3.6 METRE LENGTHS

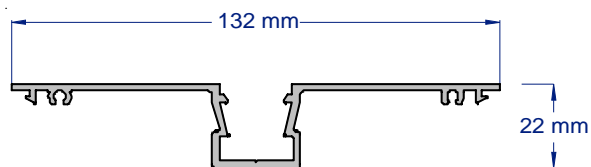

SAP316
SNAP IN POCKET GLAZE
2.8 & 3.6 METRE LENGTHS

ISSUE NO 19.9
DATE : 01/09/2019
REPLACES : 01/07/2017
SUBJECT TO CHANGE WITHOUT NOTICE

SAPPHIRE

BESPOKE SOLUTIONS FOR ALUMINIUM

92MM MAXLINE® GEN 1

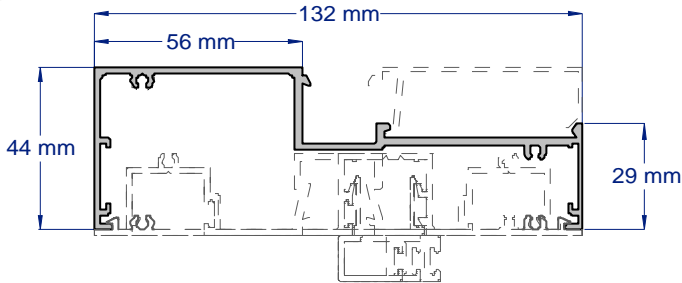

SAP319L
45MM SILL/TRANSOM
COMPLIES WITH AS1428.1 2009
2.8 & 3.6 METRE LENGTHS

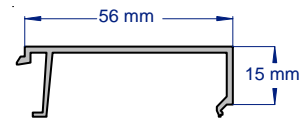

SAP320L
45MM SILL BEAD
2.8 & 3.6 METRE LENGTHS

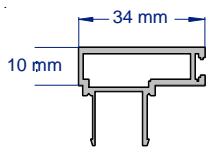

SAP317
35MM DOORSTOP
2.8 & 3.6 METRE LENGTHS

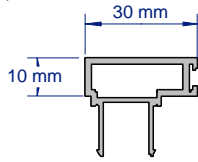

SAP318B
40MM DOORSTOP
2.8 & 3.6 METRE LENGTHS

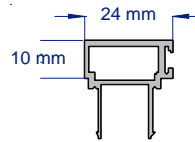

SAP318
45MM DOORSTOP
2.8 & 3.6 METRE LENGTHS

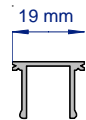

SAP023
POCKET INFIL
2.8 & 3.6 METRE LENGTHS

PLEASE NOTE! DOOR STOP THICKNESS STATED ALLOWS FOR A 5MM SETBACK FROM THE EDGE OF THE FRAME WHEN DOOR IS HUNG

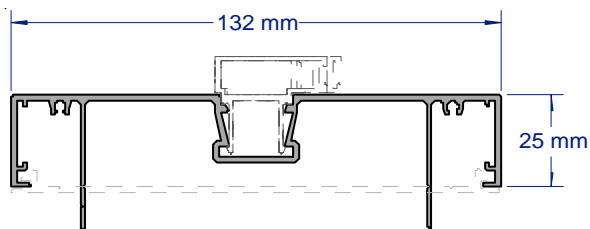

SAP314
132MM MAINFRAME 25MM
DOES NOT COMPLY WITH AS1428.1 2009
2.8 & 3.6 METRE LENGTHS

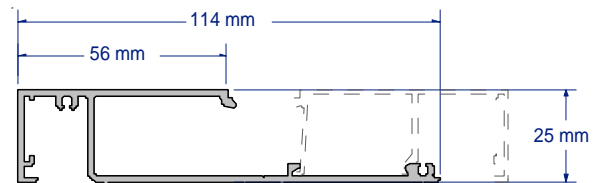

SAP319
132MM GLAZING SILL 25MM
2.8 & 3.6 METRE LENGTHS

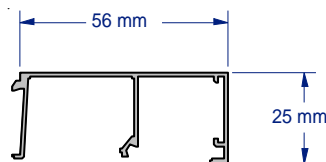

SAP320
92MM MAXLINE GLAZING BEAD 25MM
2.8 & 3.6 METRE LENGTHS

SAPPHIRE

BESPOKE SOLUTIONS FOR ALUMINIUM

92MM MAXLINE® GEN 1

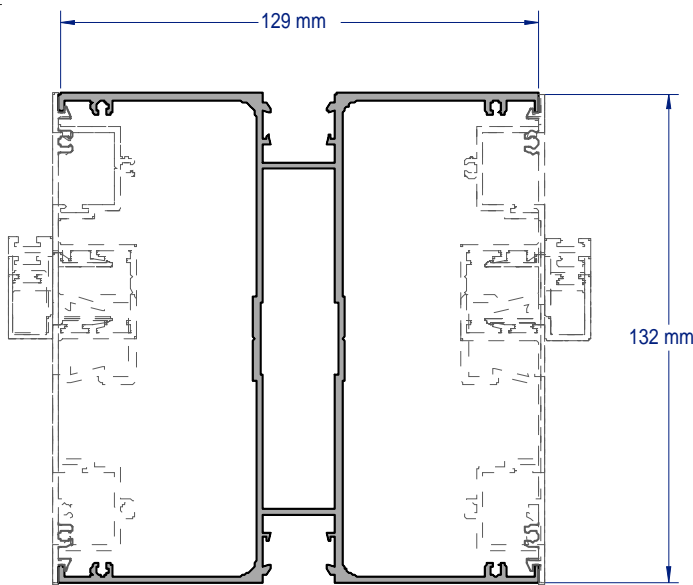

SAP324

132MM 4 WAY POST
COMPLIES WITH AS1428.1 2009
2.8 & 3.6 METRE LENGTHS

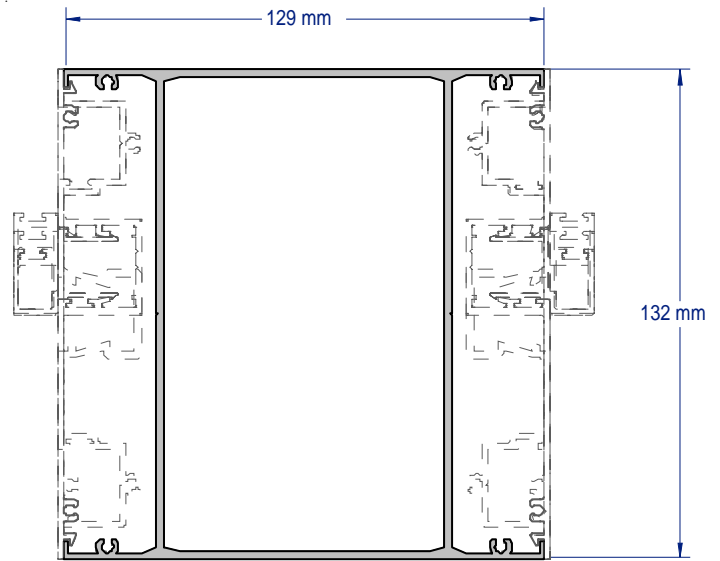

SAP324D

132MM 2 WAY POST
COMPLIES WITH AS1428.1 2009
2.8 & 3.6 METRE LENGTHS

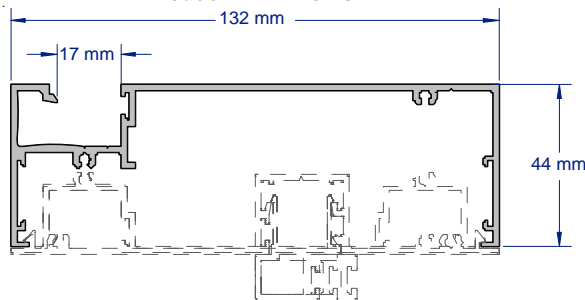

SAP337

FRONT GLAZE FRAME / MULLION
COMPLIES WITH AS1428.1 2009
2.8 & 3.6 METRE LENGTHS

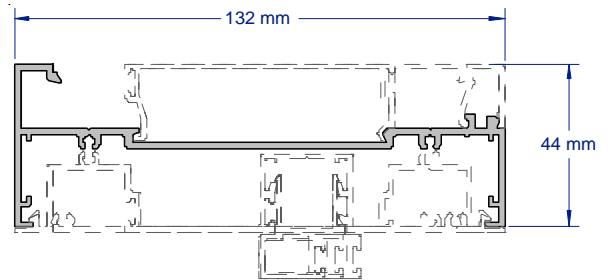

SAP340

FRONT & DOUBLE GLAZE SILL / MULLION / TRANSOM
COMPLIES WITH AS1428.1 2009
2.8 & 3.6 METRE LENGTHS

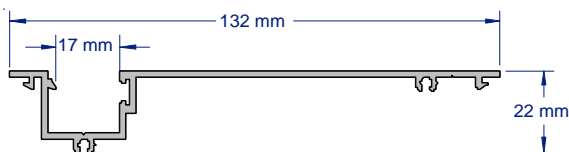

SAP338

FRONT GLAZE SNAPIN
2.8 & 3.6 METRE LENGTHS

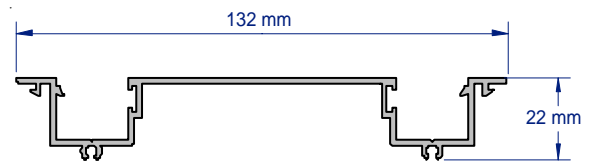

SAP341

DOUBLE GLAZE SNAPIN
2.8 & 3.6 METRE LENGTHS

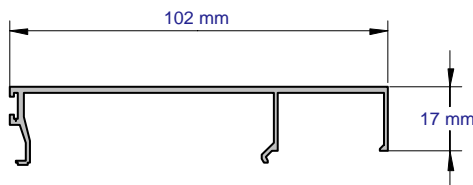

SAP339

FRONT GLAZE SILL BEAD
2.8 & 3.6 METRE LENGTHS

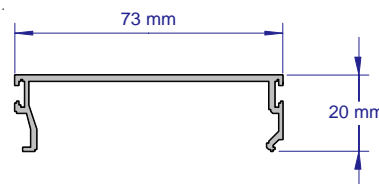

SAP343

DOUBLE GLAZE CAP
2.8 & 3.6 METRE LENGTHS

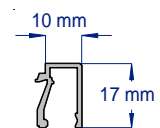

SAP105

GLAZING BEAD
2.8 & 3.6 METRE LENGTHS

ISSUE NO 19.9

DATE : 01/09/2019

REPLACES : 01/07/2017

SUBJECT TO CHANGE WITHOUT NOTICE

SAPPHIRE

BESPOKE SOLUTIONS FOR ALUMINIUM

ALUMINIUM DOOR

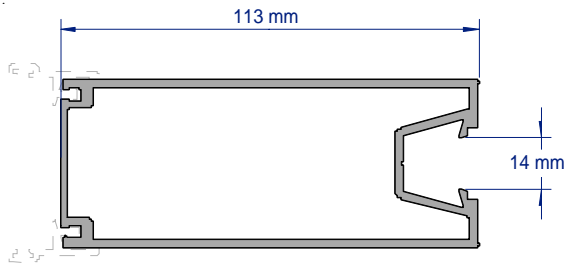

SAP416
PIVOT WIDE STILE
2.8 & 3.6 METRE LENGTHS

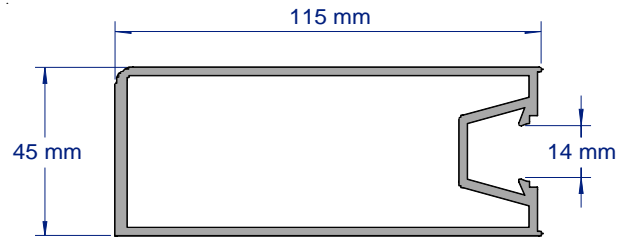

SAP417
SLIDING HINGE WIDE STILE
2.8 & 3.6 METRE LENGTHS

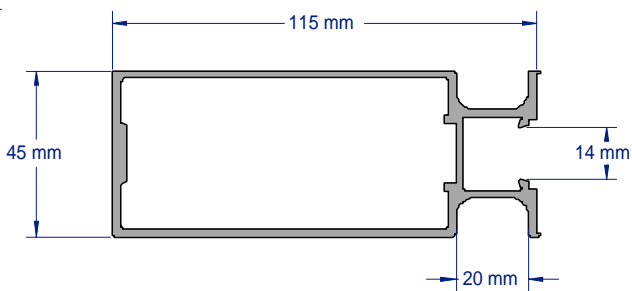

SAP418
SLIDING WIDE LOCK STILE WITH FINGERPULL HANDLE
2.8 & 3.6 METRE LENGTHS

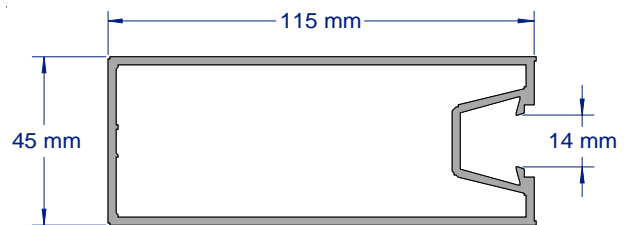

SAP419
115MM PLAIN WIDE LOCK/HINGE STILE
2.8 & 3.6 METRE LENGTHS

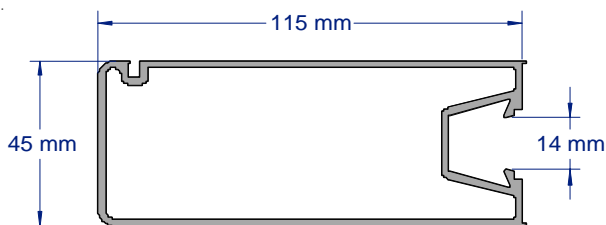

SAP420
115MM WIDE SLIDER STILE
2.8 & 3.6 METRE LENGTHS

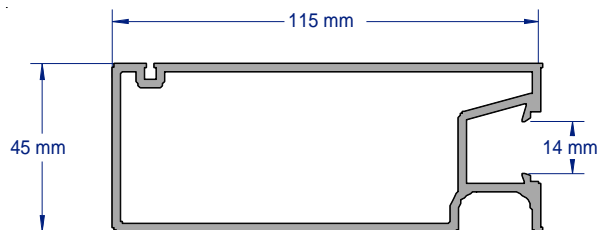

SAP420H
115MM WIDE SLIDER STILE WITH FINGERPULL HANDLE
2.8 & 3.6 METRE LENGTHS

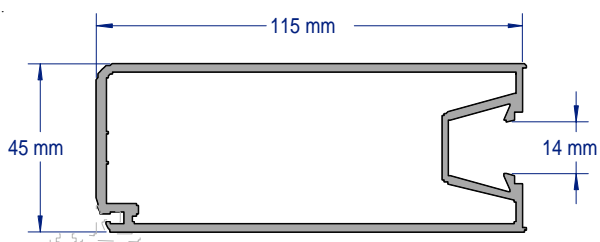

SAP421
115MM WIDE LOCK STILE
2.8 & 3.6 METRE LENGTHS

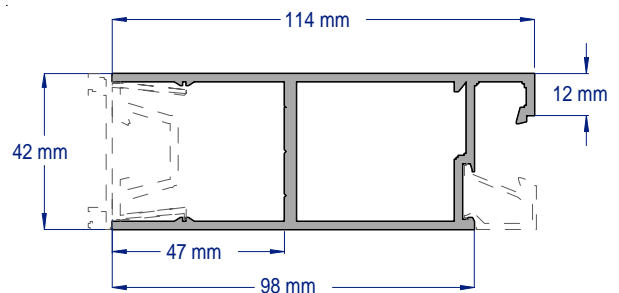

SAP426
115MM TOP/BOTTOM MID RAIL
2.8 & 3.6 METRE LENGTHS

PLEASE NOTE ! ALUMINIUM DOOR IS ONLY AVAILABLE IN SA , ALL OTHER STATES USE SHOOSHLINE

ISSUE NO 19.9

DATE : 01/09/2019

REPLACES : 01/07/2017

SUBJECT TO CHANGE WITHOUT NOTICE

SAPPHIRE

BESPOKE SOLUTIONS FOR ALUMINIUM

ALUMINIUM DOOR

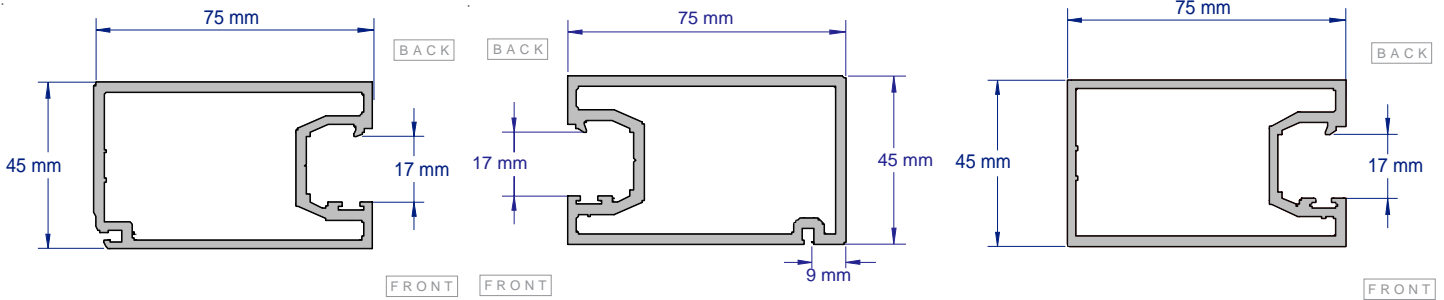

SAP522
75MM LOCK STILE
2.8 & 3.6 METRE LENGTHS

SAP523
75MM SLIDE STILE
2.8 & 3.6 METRE LENGTHS

SAP524
75MM PLAIN STILE (LOCK/HINGE)
2.8 & 3.6 METRE LENGTHS

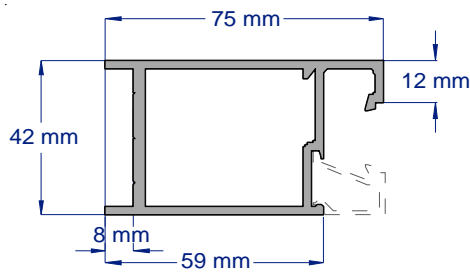

SAP425
75MM RAIL
2.8 & 3.6 METRE LENGTHS

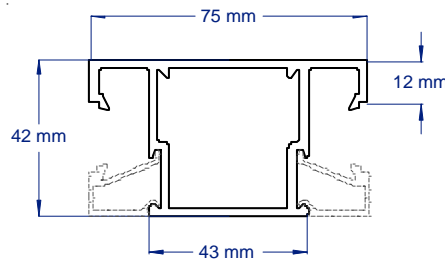

SAP433
75MM MIDRAIL
2.8 & 3.6 METRE LENGTHS

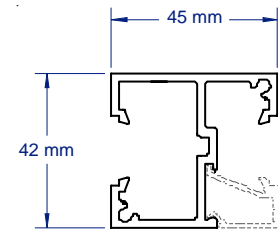

SAP432
45MM MIDRAIL
6.5 METRE LENGTHS

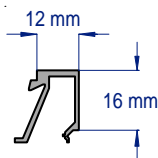

SAP428
RAIL BEAD
2.8 & 3.6 METRE LENGTHS

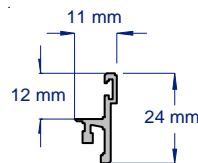

SAP429
MEETING STILE ADAPTOR
6.5 METRE LENGTHS

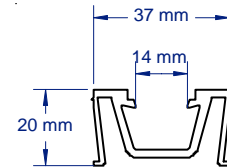

SAP431
MIDRAIL ADAPTOR FOR SAP426
6.5 METRE LENGTHS

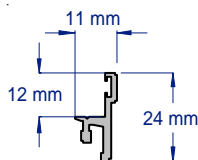

SAP429
MEETING STILE ADAPTOR
6.5 METRE LENGTHS
SUITS SAP521,522

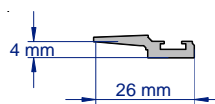

SAP430
INTERLOCK (SMALL)
6.5 METRE LENGTHS

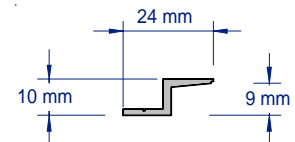

SAP434
INTERLOCK (LARGE)
6.5 METRE LENGTHS

PLEASE NOTE ! ALUMINIUM DOOR IS ONLY AVAILABLE IN SA , ALL OTHER STATES USE SHOOSHLINE

ISSUE NO 19.9

DATE : 01/09/2019
REPLACES : 01/07/2017
SUBJECT TO CHANGE WITHOUT NOTICE

SAPPHIRE

BESPOKE SOLUTIONS FOR ALUMINIUM

SHOOSHLINE DOOR

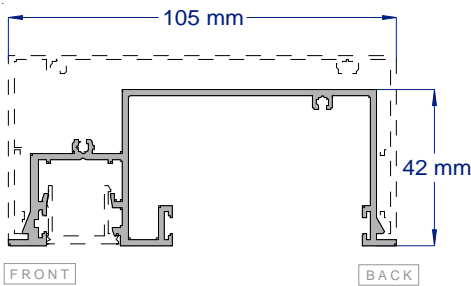

SAP480

SNAP IN GLAZING SLIDE HEAD CHANNEL
2.8 & 3.6 METRE LENGTHS
(MUST BE USED IN CONJUNCTION WITH MICROLINE
ONLY FOR FRONT FRAMING)

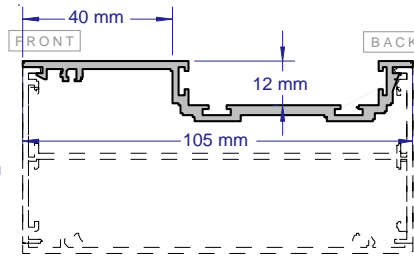

SAP481

SNAP IN CLOSING CHANNEL
2.8 & 3.6 METRE LENGTHS
(MUST BE USED IN CONJUNCTION WITH MICROLINE
ONLY FOR FRONT FRAMING)

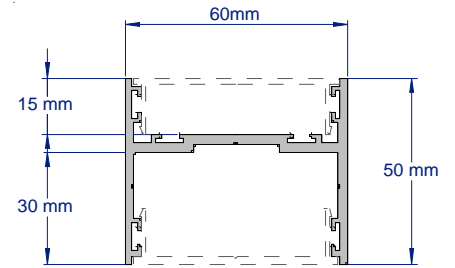

SAP582

50MM OVERHEAD/CLOSING CHANNEL
2.8, 3.6 & 5.6 METRE LENGTHS
NEW VERSION AVAILABLE FROM 01/07/2017, OLD VERSION IS
SAP482

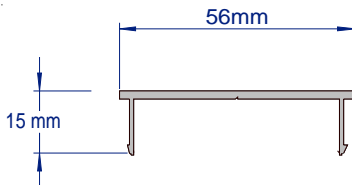

SAP583

CLOSING CHANNEL COVER
2.8 & 3.6 METRE LENGTHS
NEW VERSION AVAILABLE FROM 01/07/2017, OLD VERSION IS
SAP483

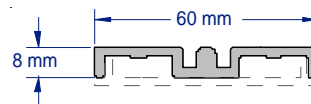

SAP484

FLOOR TRACK - TOP
3.6 & 5.6 METRE LENGTHS

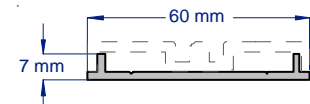

SAP484/B

FLOOR TRACK - BASE
3.6 & 5.6 METRE LENGTHS

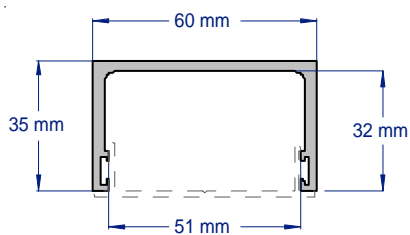

SAP487

35MM OVERHEAD CHANNEL
6.5 METRE LENGTHS

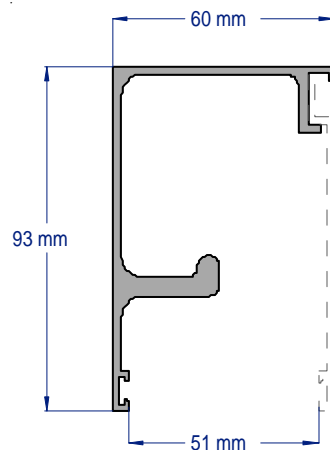

SAP485

SHOOSHLINE OVERHEAD PELMET
6.5 METRE LENGTHS

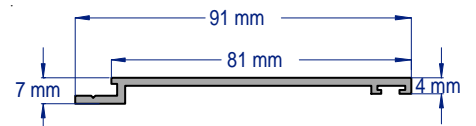

SAP586

SHOOSHLINE OVERHEAD PELMET COVER
6.5 METRE LENGTHS

ISSUE NO 19.9

DATE : 01/09/2019

REPLACES : 01/07/2017

SUBJECT TO CHANGE WITHOUT NOTICE

SAPPHIRE

BESPOKE SOLUTIONS FOR ALUMINIUM

SKIRTING & TRIMS

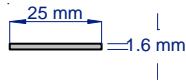

SAS25X1.6
25MM TRIM/SKIRTING
3.6 METRE LENGTHS

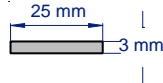

SAS25X3
25MM TRIM/SKIRTING
3.6 METRE LENGTHS

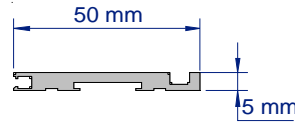

SAP50x5SK
50MM X 5MM REBATE SKIRTING
3.6 METRE LENGTHS

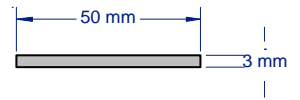

SAS50X3
50MM X 3MM FLATBAR/SKIRTING
3.6 METRE LENGTHS

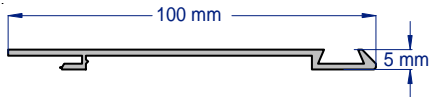

SAP009
100MM SCREWFIX SKIRTING
3.6 METRE LENGTHS

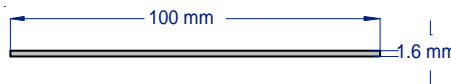

SAS100X1.6
100MM X 1.6MM FLATBAR/SKIRTING
3.6 METRE LENGTHS

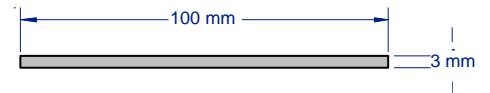

SAS100X3
100MM X 3MM FLATBAR/SKIRTING
3.6 METRE LENGTHS

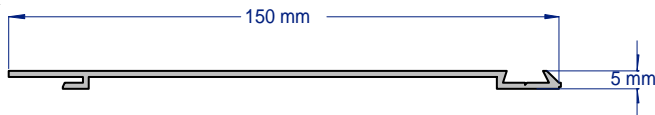

SAP009/B
150MM SCREWFIX SKIRTING
3.6 METRE LENGTHS

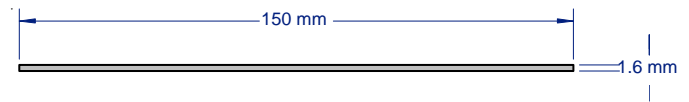

SAS150X1.6
EXTRUDED 150MM X 1.6MM FLATBAR/SKIRTING
3.6 METRE LENGTHS

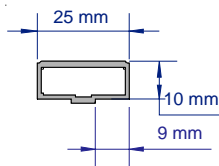

SAP25T
25MM STICK ON MULLION / TRANSOM TRIM
2.8 & 3.6 METRE LENGTHS

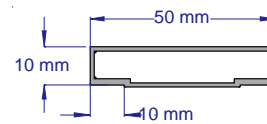

SAP50T
50MM STICK ON MULLION / TRANSOM TRIM
2.8 & 3.6 METRE LENGTHS

Use the following wedge and glass options for
Microline, Wideline Gen 3, Frontline Gen 2, 76mm Maxline Gen 2, 92mm Maxline Front / Double Glaze and Shooshline Doors

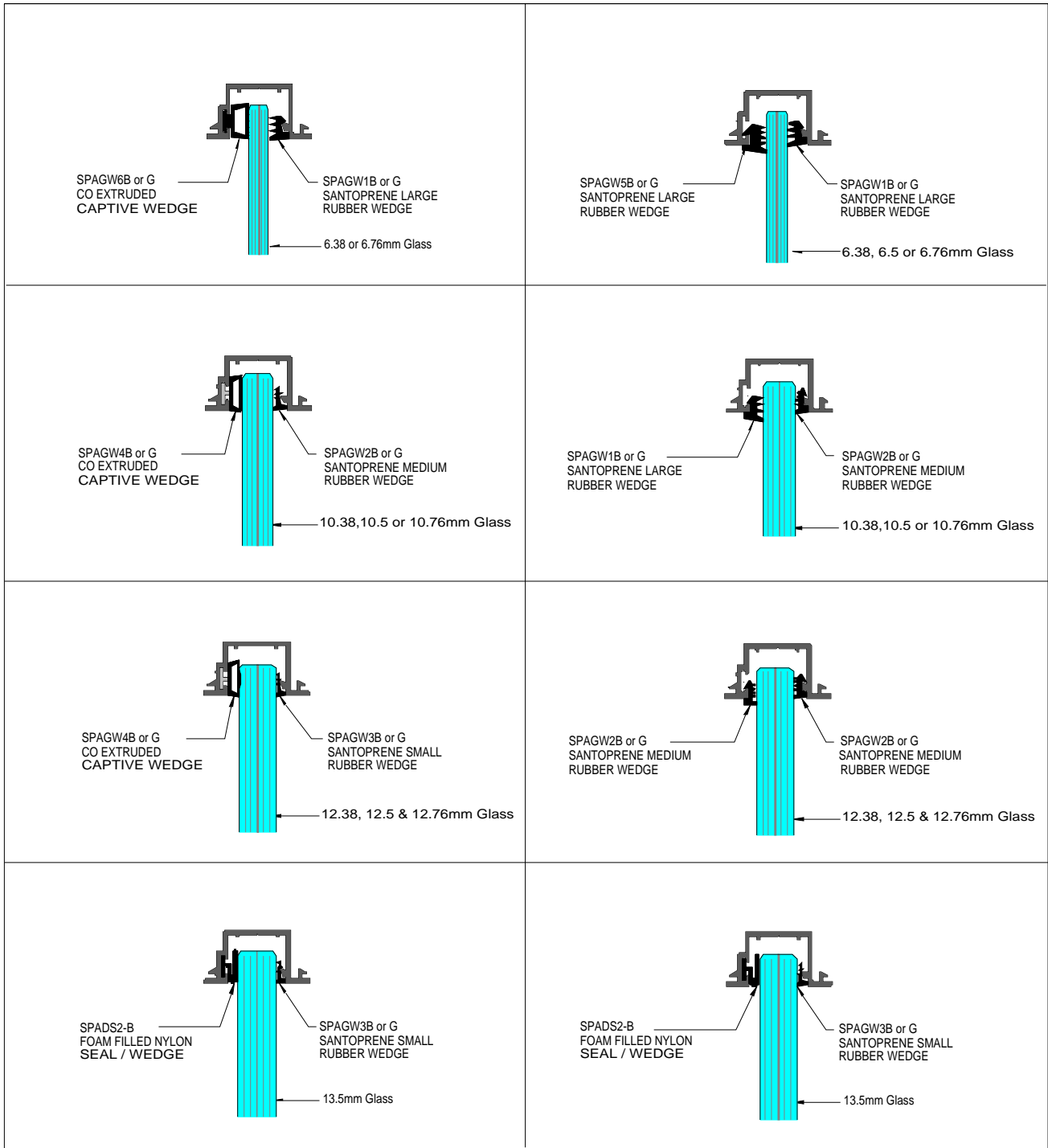

SLIDE IN CAPTIVE OPTION

PUSH IN WEDGE OPTION

ISSUE NO 19.9

DATE : 01/09/2019

REPLACES : 01/07/2017

SUBJECT TO CHANGE WITHOUT NOTICE

Use the following wedge and glass options for **left side**
Wideline Gen 2, Frontline Gen 1, 92mm Maxline Gen 1 Centre Glaze
 Use the following wedge and glass options for **right side**
Sapphire 400 Entry Doors

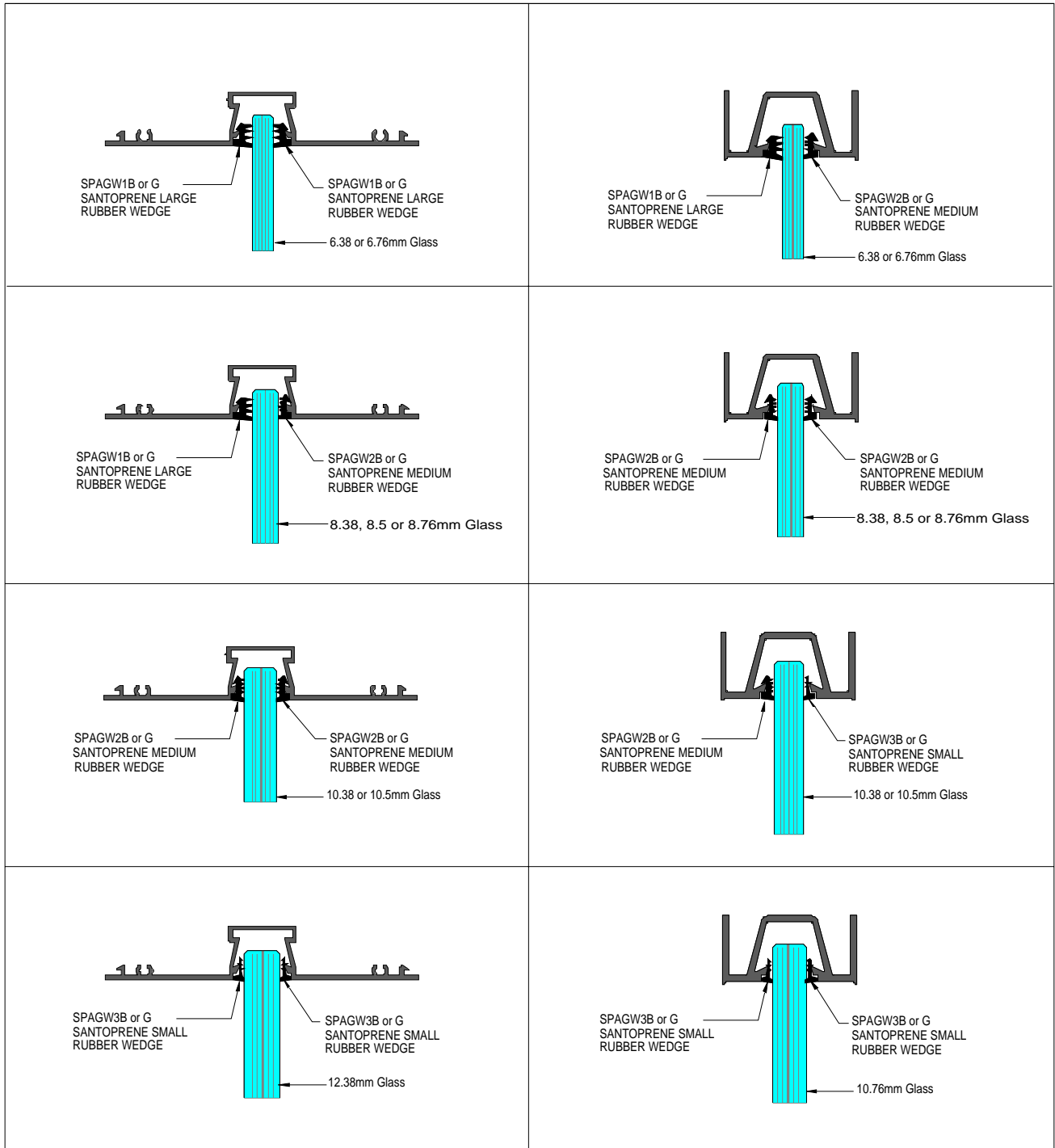

ISSUE NO 19.9

DATE : 01/09/2019

REPLACES : 01/07/2017

SUBJECT TO CHANGE WITHOUT NOTICE

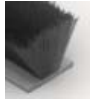

SPADS1-B or G
MOHAIR SEAL 6.5mm H
BLACK OR GREY
100 METRE ROLLS

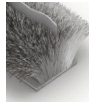

SPADS1F-B
MOHAIR FIN SEAL 6.5mm H
BLACK ONLY
350 METRE ROLLS



SPADS2-B
NYLON FOAM FILLED ACOUSTIC SEAL/WEDGE
BLACK ONLY
305 METRE ROLLS OR BY THE METRE



SPADS3-B or G
PVC BULB SEAL 6MM HIGH
BLACK OR GREY
100 METRE ROLLS OR BY THE METRE



SPADS4-B or G
SANTOPRENE ACOUSTIC BULB SEAL
BLACK OR GREY
100 METRE ROLLS
USE WITH SAP046



SPADS5-B
CO-EX BULB SEAL - 8MM H
BLACK ONLY
100 METRE ROLLS OR BY THE METRE
USE WITH SAP108 - 40MM DOORS



SPADS6-B
NYLON FOAM FILLED BULB SEAL - 6.5MM H
BLACK ONLY
500 METRE ROLLS OR BY THE METRE



SPASKC-B or G
SKIRTING INFIL COVER
BLACK OR GREY
100 METRE ROLLS



SPAGW1-B or G
SANTOPRENE GLAZING WEDGE - Large
BLACK OR GREY
100 METRE ROLLS



SPAGW2-B or G
SANTOPRENE GLAZING WEDGE - Medium
BLACK OR GREY
100 METRE ROLLS



SPAGW3-B or G
SANTOPRENE GLAZING WEDGE - Small
BLACK OR GREY
100 METRE ROLLS



SPAGW4-B or G
CAPTIVE CO-EX DOORSEAL / GLAZING WEDGE
10MM - 12.76MM
BLACK
100 METRE ROLLS
INSERT BEFORE FABRICATION

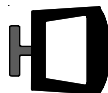

SPAGW6-B or G
CAPTIVE CO-EX DOORSEAL / GLAZING
WEDGE - 6.38MM
BLACK
100 METRE ROLLS
INSERT BEFORE FABRICATION



SPAGW9-B
ROLL IN GLAZING WEDGE - 6.38MM
BLACK
100 METRE ROLLS
ALT OPTION FOR SPAGW6-B-1



SPAGW10-B
ROLL IN GLAZING WEDGE - 10.38 - 12.50MM
BLACK
100 METRE ROLLS
ALT OPTION FOR SPAGW4-B-1

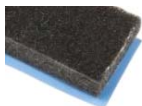

SPAGT1-B-1
Double Sided Black Foam Glazing Tape
9.0MM (W) X 1.6MM (H)
BLACK 45.7 METRE ROLLS

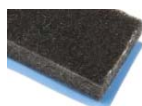

SPAGT3-B-1
Double Sided Black Foam Glazing Tape
9.0MM (W) X 3.2MM (H)
BLACK 22.85 METRE ROLLS

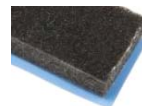

SPAGT4-B-1
Double Sided Black Foam Glazing Tape
9.0MM (W) X 4.8MM (H)
BLACK 15.2 METRE ROLLS

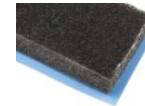

SPAGT6-B-1
Double Sided Black Foam Glazing Tape
9.0MM (W) X 6.4MM (H)
BLACK 15.2 METRE ROLLS

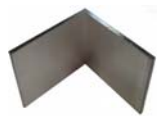

SPACS1-M-1
MICROLINE DOORJAMB CORNER STAKE
60MM X 60MM X 55MM
BAGS OF 50



SPACS3-M-1
ZINC PRE DRILL CORNER STAKE - VERT 90
50MM X 50MM X 15MM
BAGS OF 100
AVAILABLE 01/12/2018



SPACS5 B or G
SKIRTING CORNER/END STAKE
TO SUIT 100MM - 150MM SCREWFIX
BAGS OF 50



SPACS7-M-1
CRINKLED CORNER STAKE
80MM X 17.5MM
BAGS OF 50



SPACS6-M-1
CRINKLED CORNER STAKE - VERT 90
60MM X 60MM X 17.5MM
BAGS OF 50



SPACS8-M-1
CRINKLED CORNER STAKE - HORIZONTAL
60MM X 60MM X 17.5MM
BAGS OF 50

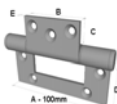

SPAHG168
ALUMINIUM TAPERLEAF
FASTFIX HINGE
100MM X 50MM EACH



SPAHG105
ALUMINIUM HEAVYDUTY
SINGLE FASTFIX HINGE
130MM X 50MM EACH

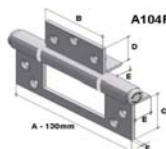

SPAHG104
ALUMINIUM HEAVYDUTY
DOUBLE FASTFIX HINGE
130MM X 50MM EACH



SPASTSC
HALF MOON DOORSTOP
ALSO IN P/COAT AND CHROME
EACH



SSASP-M-1
ALUMINIUM SPIGGOT SET
4 LONG BOLTS



SSATHR-M-1
TOP HUNG ROLLER
PAIRS (SUITS SAP485 ONLY)



SSABTR-M-1
BOTTOM TRACK ROLLERS
EACH (150KG LOAD - SUITS SAP484)



SSAFGC-M-1
SLIDING DOOR FLOOR GUIDE
EACH (SUITS SAP535)



SSADS12 B or G
MOHAIR SEAL FOR SHOOSHLINE 11MM H
BLACK OR GREY
PER MTR



SSADS13 B or G
MOHAIR SEAL FOR SHOOSHLINE 13MM H
BLACK OR GREY
PER MTR



SSADS14 B or G
SLIDING DOOR ACOUSTIC
SANTOPRENE SEAL
100 METRE ROLLS



SSADS16 B
NYLON FOAM FILLED ACOUSTIC SEAL TO
SUIT SAP429
AVAILABLE PER METRE

Australia

NEW SOUTH WALES

Sapphire Aluminium Pty Ltd
MANUFACTURERS FOR AUST & ASIA
19 -29 Pile Road,
Somersby Industrial Estate
SOMERSBY New South Wales 2250

Phone : 61 2 4304 3555
Facsimile : 61 2 4304 3533
email : sapsom@sapal.com.au

VICTORIA

Sapphire Aluminium Pty Ltd
TECHNICAL INFORMATION AND SPECIFICATION
PO Box 7534
Beaumaris Victoria 3193

Phone : 61 3 9589 4222
Facsimile : 61 3 9589 4322
email : sapvic@sapal.com.au

SOUTH AUSTRALIA

Trojan Aluminium Pty Ltd
Cnr Cross Keys Road & CB Fisher Drive
CAVAN South Australia 5094

Phone : 61 8 8260 6055
Facsimile : 61 8 8262 2260
email : trojan@bigpond.net.au

WESTERN AUSTRALIA

Westgyp Pty Ltd
39 Ledger Road
BALCATT Western Australia 6021

Phone : 61 8 9240 5488
Facsimile : 61 8 9240 7433
email : sales@westgyp.com.au

QUEENSLAND

Coming Soon
Refer to Sapphire Somersby

NORTH QUEENSLAND

Coming Soon
Refer to Sapphire Somersby

NORTHERN TERRITORY

Coming Soon
Refer to Sapphire Somersby

TASMANIA

Refer to Sapphire Somersby