

SAPPHIRE

BESPOKE SOLUTIONS FOR ALUMINIUM

PARTITION SUITES

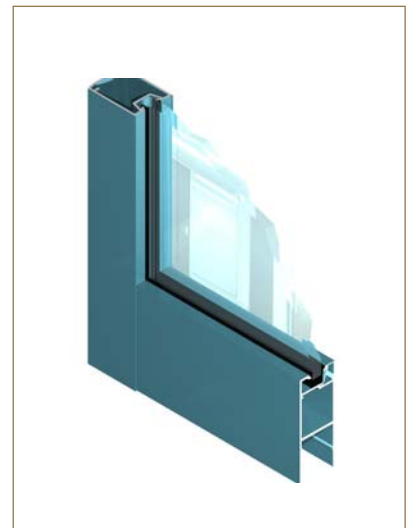
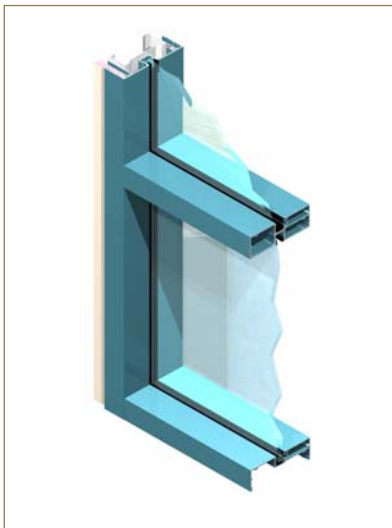
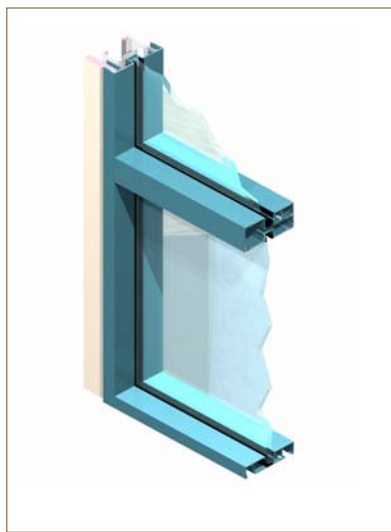

OVERVIEW - 21.3

sapal.com.au

FLEXIBILITY

Partitions are built on site allowing minor changes to design and layout to be easily accommodated with **NO EXTRA COST AND NO PROJECT DELAY** that comes from factory assembled systems.

TAILOR MADE

With so many profiles and interlocking shapes, Sapphire partitions can be configured in so many unique ways. This is a product that will excite any architect / designer.

COMPETITIVE PRICE

Sapphire partition frames can be used with standard drywall. Plasterboard, steel stud frames, glass and timber doors can be sourced locally. This ensures that Sapphire partitions are very price competitive.

SUPERFAST LEADTIME

Sapphire strives to deliver all standard sections within two to three weeks regardless of finish. (NB : for export markets customs procedures may delay delivery in some countries). Sapphire will ensure that challenging project schedules will not be compromised.

COMPLIANCE WITH BCA

Sapphire Partition Systems are designed to comply with Building Code of Australia (BCA) and in particular to AS1428.1-2009 and AS1288-2006 ensuring your fitout will comply with the relevant codes.

SPEEDY INSTALLATION

Sapphire aluminium is prefinished so that no touch up is required after installation. All necessary accessories are supplied as part of the system. Aluminium is light and easy to cut on site. Snap together profiles reduce construction and on site labour costs.

SUPERIOR SOUND RATINGS

Sapphire Partition Systems allow you to meet stringent sound ratings from RW36 - RW50

EXCITING RANGE OF ANODISED FINISHES

Anodising is the most durable and beautiful finish that can be applied to aluminium as it highlights and enhances the natural characteristics of aluminium.

BEING GREEN

When you specify/purchase Sapphire partitions you are taking care of the environment as our products are made from recycled and primary aluminium. Combining this with an anodised finish you have a product that is 100% recyclable and free of harmful VOC's.



ISSUE NO 21.3

DATE : 01/03/2021
REPLACES : 01/09/2020
SUBJECT TO CHANGE WITHOUT NOTICE

SAPPHIRE

BESPOKE SOLUTIONS FOR ALUMINIUM

MICROLINE® 40

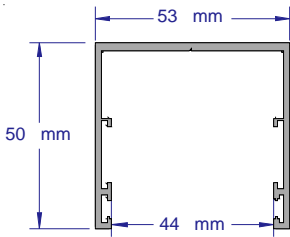

SAPMSH
SUB HEAD - DEFLECTION
3.6 METRE LENGTHS

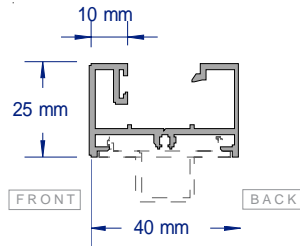

SAP103
GLAZING FRAME
2.8 & 3.6 METRE LENGTHS

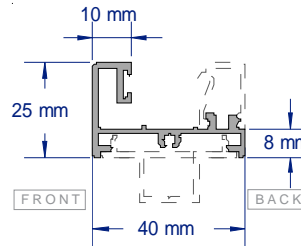

SAP104
GLAZING SILL
2.8 & 3.6 METRE LENGTHS

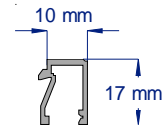

SAP105
GLAZING BEAD
2.8 & 3.6 METRE LENGTHS

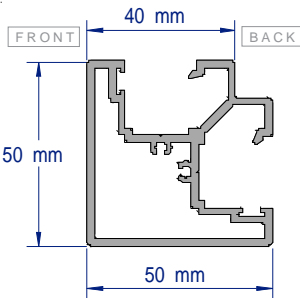

SAP106
50MM CORNER POST
2.8 & 3.6 METRE LENGTHS

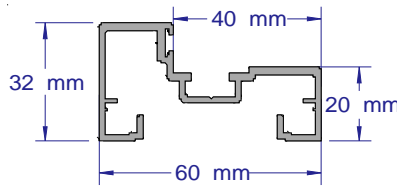

SAP107
35MM DOORFRAME
2.8 & 3.6 METRE LENGTHS

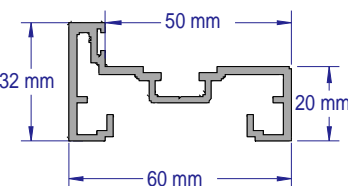

SAP108
45MM DOORFRAME
2.8 & 3.6 METRE LENGTHS

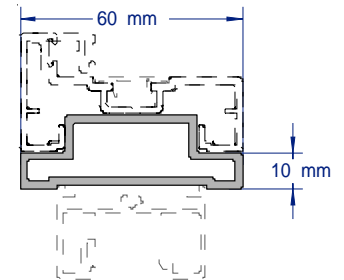

SAP109
ELECTRIC STRIKE ADAPTOR
2.8 & 3.6 METRE LENGTHS

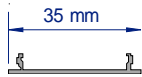

SAP111
FLAT SNAPIN
2.8 & 3.6 METRE LENGTHS

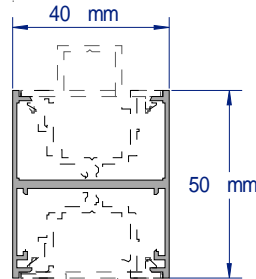

SAP113
50MM MULTICAP/WALLSTARTER
2.8 & 3.6 METRE LENGTHS

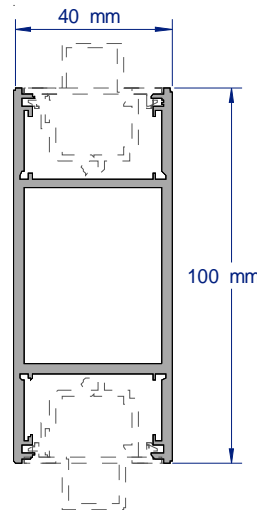

SAP114
100MM MULTICAP/TRANSOM
2.8 & 3.6 METRE LENGTHS

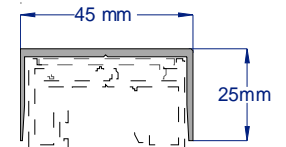

SAP102
DEFLECTION HEAD / WALL STARTER
2.8 & 3.6 METRE LENGTHS

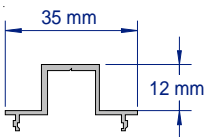

SAP111C
SHADOWLINE SNAPIN
2.8 & 3.6 METRE LENGTHS

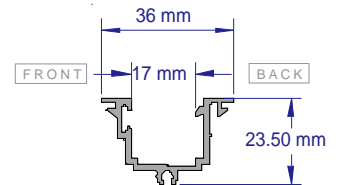

SAP116
GLAZING INFILL
2.8 & 3.6 METRE LENGTHS

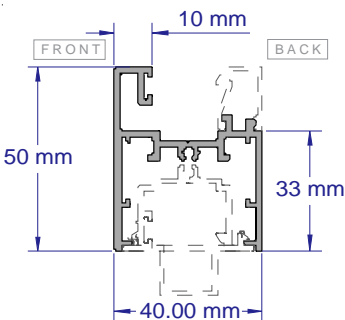

SAP119
50MM TRANSOM/SILL
NEW VERSION
2.8 & 3.6 METRE LENGTHS

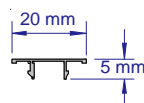

SAPC20
COVER CAP
2.8 & 3.6 METRE LENGTHS

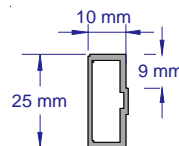

SAP25T
25MM STICK ON MULLION / TRANSOM TRIM
2.8 & 3.6 METRE LENGTHS

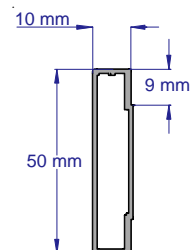

SAP50T
50MM STICK ON MULLION / TRANSOM TRIM
2.8 & 3.6 METRE LENGTHS

ISSUE NO 21.3

DATE : 01/03/2021
REPLACES : 01/09/2020
SUBJECT TO CHANGE WITHOUT NOTICE

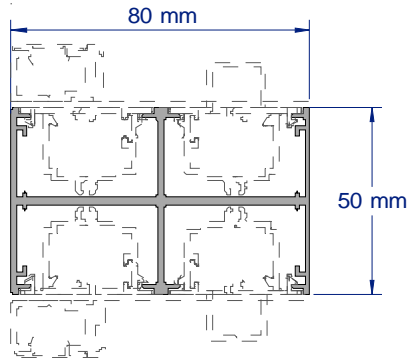

SAP130

80MM MULTICAP/WALLSTARTER/DOORFRAME - SINGLE/DOUBLE GLAZE
2.8 & 3.6 METRE LENGTHS

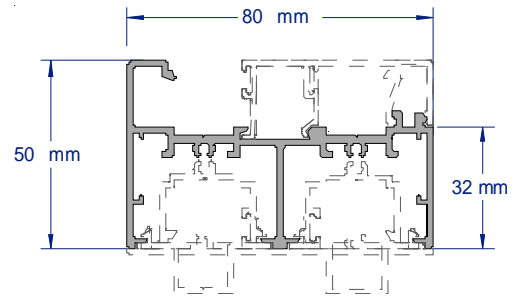

SAP140

80MM TRANSOM/SILL - SINGLE/DOUBLE GLAZE
2.8 & 3.6 METRE LENGTHS

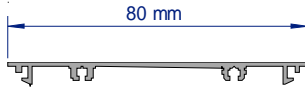

SAP131

80MM FLAT SNAPIN
2.8 & 3.6 METRE LENGTHS

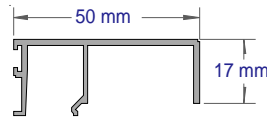

SAP139

80MM SINGLE GLAZE BEAD
2.8 & 3.6 METRE LENGTHS

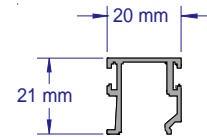

SAP143

80MM DOUBLE GLAZE CAP
2.8 & 3.6 METRE LENGTHS

MISCELLANEOUS

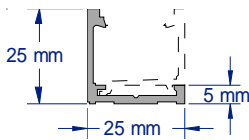

SAP044

25MM GLAZING FRAME
2.8 & 3.6 METRE LENGTHS

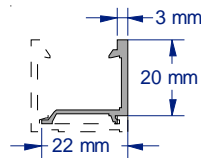

SAP045

25MM GLAZING BEAD
2.8 & 3.6 METRE LENGTHS

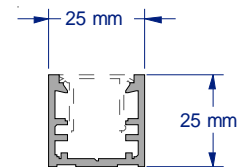

SAP047

GLAZING CHANNEL
2.8 & 3.6 METRE LENGTHS

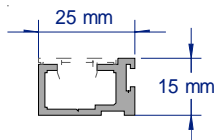

SAP046

ACOUSTIC DOORSTOP
2.8 & 3.6 METRE LENGTHS

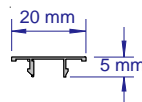

SAPC20

ACOUSTIC SNAP IN COVER
2.8 & 3.6 METRE LENGTHS

SAPPHIRE

BESPOKE SOLUTIONS FOR ALUMINIUM

WIDELINE® GEN 3

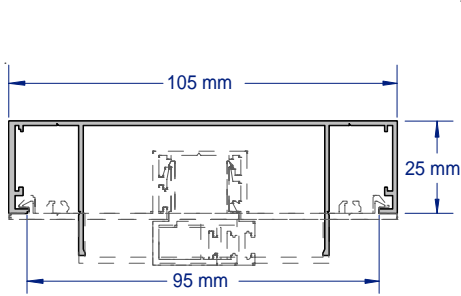

SAP010
25MM CAPPING HEAD / FRAME
2.8 & 3.6 METRE LENGTHS

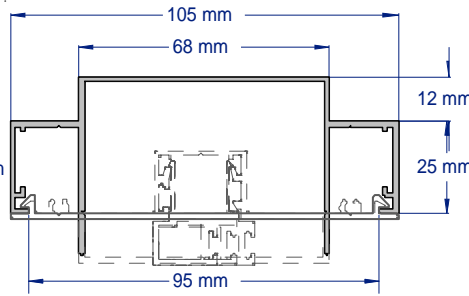

SAP010C
25MM SHADOWLINE CAPPING HEAD / FRAME
2.8 & 3.6 METRE LENGTHS

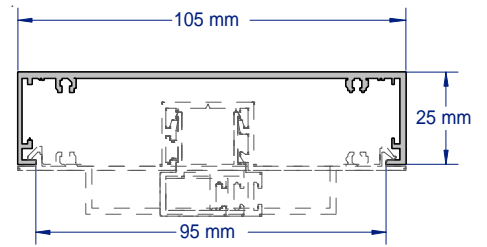

SAP012
25MM CAPPING HEAD / WALLSTARTER
2.8 & 3.6 METRE LENGTHS

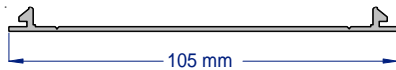

SAP011
SNAP IN FLUSH ADAPTOR
2.8 & 3.6 METRE LENGTHS

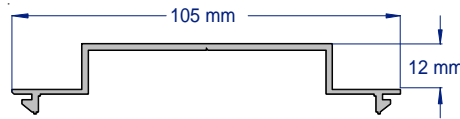

SAP011C
SNAP IN SHADOWLINE ADAPTOR
2.8 & 3.6 METRE LENGTHS

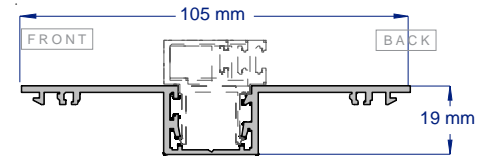

PLEASE NOTE POCKET DIRECTION IF USING AS A DOORFRAME

SAP016
SNAP IN POCKET GLAZE
2.8 & 3.6 METRE LENGTHS

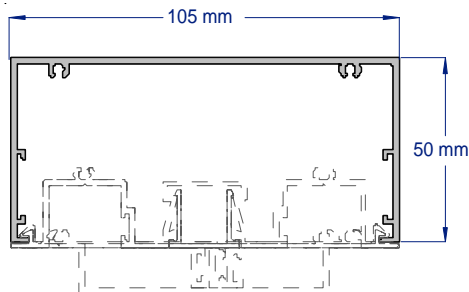

SAP012L
50MM CAPPING HEAD / WALLSTARTER
COMPLIES WITH AS1428.1 2009
2.8 & 3.6 METRE LENGTHS

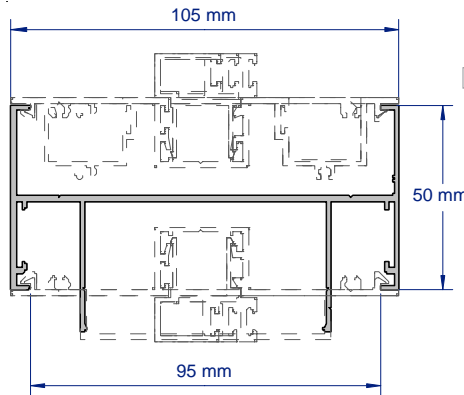

SAP013L
50MM CAPPING HEAD / FRAME
COMPLIES WITH AS1428.1 2009
2.8 & 3.6 METRE LENGTHS

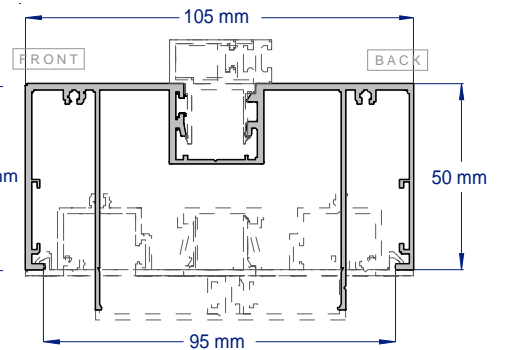

PLEASE NOTE POCKET DIRECTION IF USING AS A DOORFRAME

SAP014F
50MM PLASTERBOARD POCKET FRAME
COMPLIES WITH AS1428.1 2009
2.8 & 3.6 METRE LENGTHS

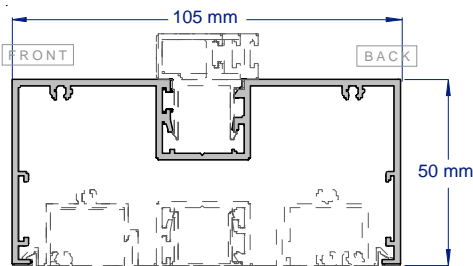

PLEASE NOTE POCKET DIRECTION IF USING AS A DOORFRAME

SAP014L
50MM POCKET CAPPING / FRAME
COMPLIES WITH AS1428.1 2009
2.8 & 3.6 METRE LENGTHS

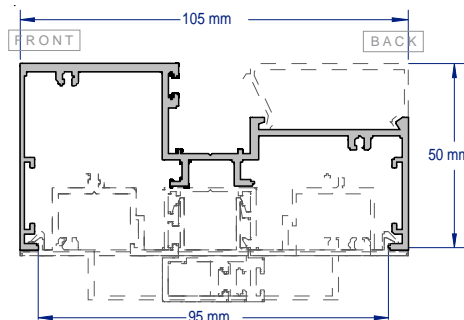

SAP019L
50MM SILL/TRANSOM
2.8 & 3.6 METRE LENGTHS

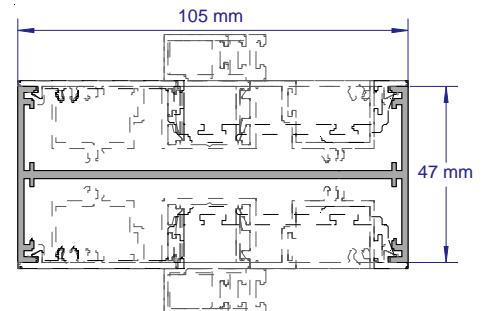

SAP021
50MM MULTICAP
COMPLIES WITH AS1428.1 2009
2.8 & 3.6 METRE LENGTHS (NEW)

ISSUE NO 21.3

DATE : 01/03/2021

REPLACES : 01/09/2020

SUBJECT TO CHANGE WITHOUT NOTICE

SAPPHIRE

BESPOKE SOLUTIONS FOR ALUMINIUM

WIDELINE® GEN 3

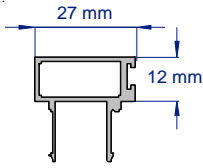

SAPDS35
35MM DOORSTOP

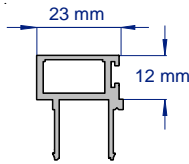

SAPDS40
40MM DOORSTOP

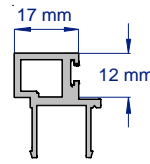

SAPDS45
45MM DOORSTOP

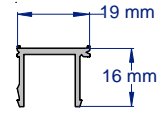

SAPPFI
POCKET FLUSH INFIL

PLEASE NOTE! DOOR STOP THICKNESS STATED ALLOWS FOR FLUSH WITH THE EDGE OF THE FRAME WHEN DOOR IS HUNG.
FRAME MUST BE INSTALLED AS SHOWN AS DOORSTOP ONLY SNAPS IN ONE WAY!
AVAILABLE IN 2.8 & 3.6 METRE LENGTHS

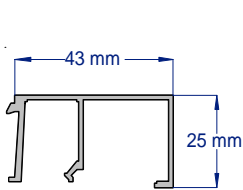

SAP020
25MM SILL BEAD
2.8 & 3.6 METRE LENGTHS

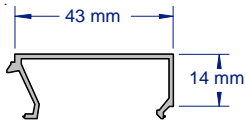

SAP022
SILL/TRANSOM BEAD
2.8 & 3.6 METRE LENGTHS

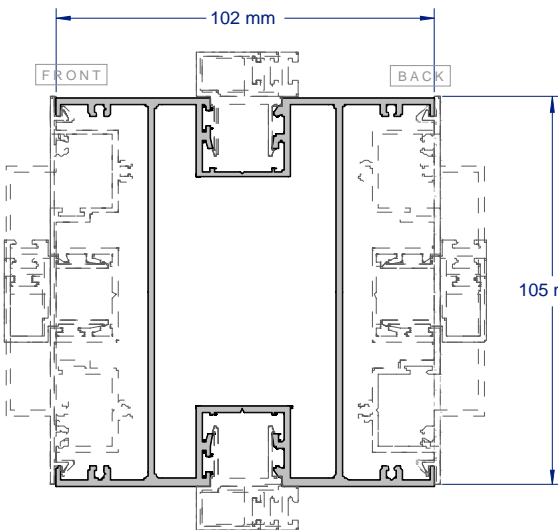

SAP024
4 WAY CORNER POST
COMPLIES WITH AS1428.1 2009
2.8 & 3.6 METRE LENGTHS

PLEASE NOTE POCKET DIRECTION IF USING AS A DOORFRAME

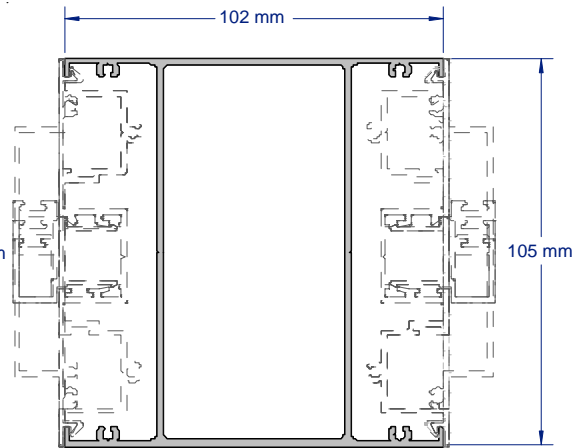

SAP024D
2 WAY POST
COMPLIES WITH AS1428.1 2009
2.8 & 3.6 METRE LENGTHS

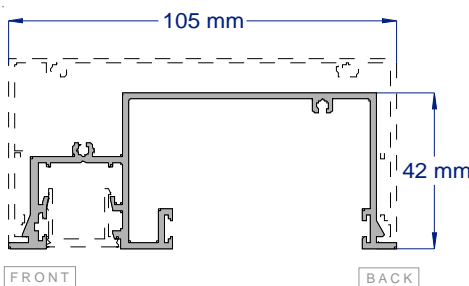

SAP480
SNAP IN GLAZING SLIDE HEAD CHANNEL
2.8 & 3.6 METRE LENGTHS
(MUST BE USED IN CONJUNCTION WITH MICROLINE ONLY FOR FRONT FRAMING)

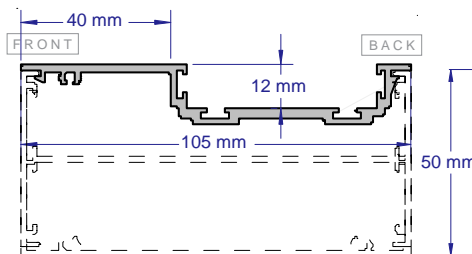

SAP481
SNAP IN CLOSING CHANNEL
2.8 & 3.6 METRE LENGTHS
(MUST BE USED IN CONJUNCTION WITH MICROLINE ONLY FOR FRONT FRAMING)

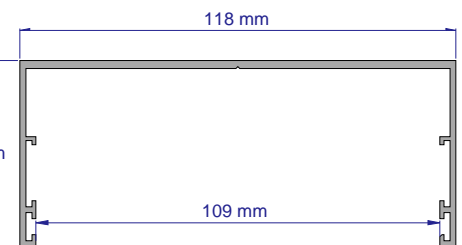

SAPWSH
SUB HEAD - DEFLECTION
3.6 METRE LENGTHS
(MUST BE USED IN CONJUNCTION WITH WIDELINE & FRONTLINE FRAMING)

ISSUE NO 19.9

DATE : 01/09/2019

REPLACES : 01/10/2018

SUBJECT TO CHANGE WITHOUT NOTICE

SAPPHIRE

BESPOKE SOLUTIONS FOR ALUMINIUM

FRONTLINE GEN 2

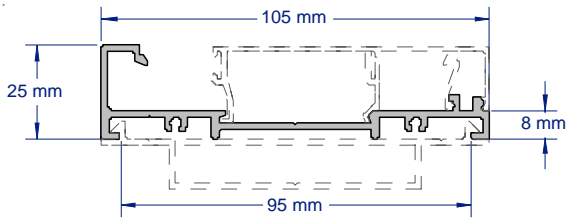

SAP033
25MM FRONT/DOUBLE GLAZING SILL
2.8 & 3.6 METRE LENGTHS

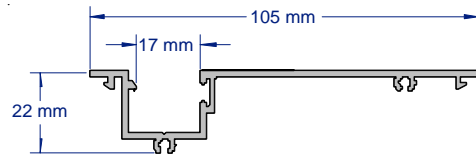

SAP038
GLAZING SNAP IN
2.8 & 3.6 METRE LENGTHS

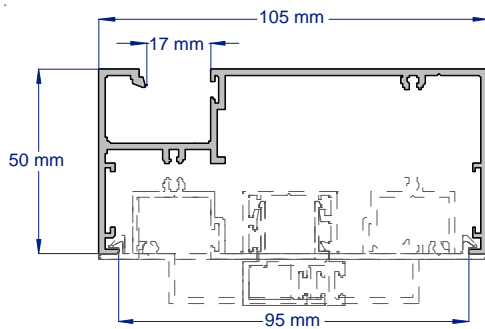

SAP037
50MM GLAZING FRAME/MULLION
COMPLIES WITH AS1428.1 2009
2.8 & 3.6 METRE LENGTHS

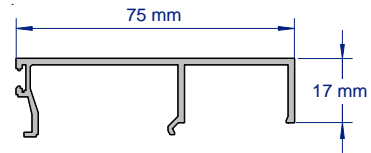

SAP039
50MM FRONT GLAZE BEAD TO SUIT
SAP033, SAP040
2.8 & 3.6 METRE LENGTHS

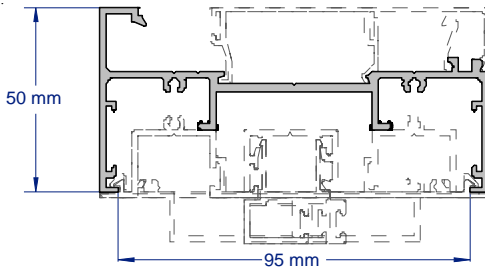

SAP040
50MM FRONT/DOUBLE GLAZE SILL/TRANSOM
COMPLIES WITH AS1428.1 2009
2.8 & 3.6 METRE LENGTHS

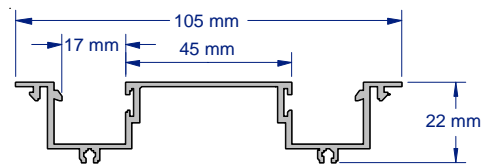

SAP041
DOUBLE GLAZING SNAP IN
COMPLIES WITH AS1428.1 2009
2.8 & 3.6 METRE LENGTHS

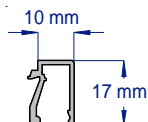

SAP105
GLAZING BEAD
2.8 & 3.6 METRE LENGTHS

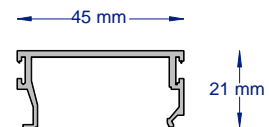

SAP043
DOUBLE GLAZE CAP TO SUIT SAP033, SAP040
2.8 & 3.6 METRE LENGTHS

ISSUE NO 21.3

DATE : 01/03/2021

REPLACES : 01/09/2020

SUBJECT TO CHANGE WITHOUT NOTICE

SAPPHIRE

BESPOKE SOLUTIONS FOR ALUMINIUM

76MM MAXLINE® GEN 2

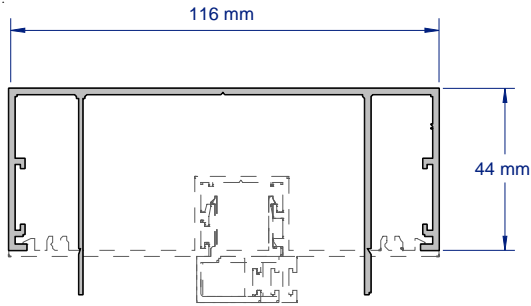

SAP210L

45MM CAPPING HEAD / WALLSTARTER
COMPLIES WITH AS1428.1 2009
2.8 & 3.6 METRE LENGTHS

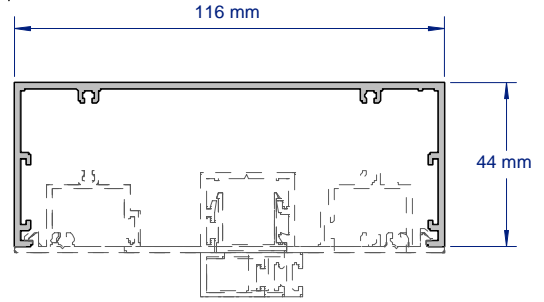

SAP212L

45MM CAPPING HEAD / FRAME
COMPLIES WITH AS1428.1 2009
2.8 & 3.6 METRE LENGTHS

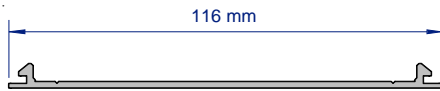

SAP211

SNAP IN FLUSH ADAPTOR
2.8 & 3.6 METRE LENGTHS
116 mm

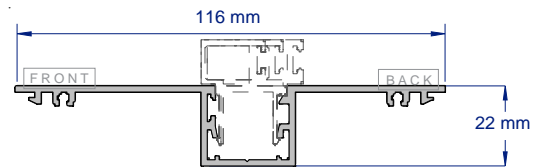

SAP216

SNAP IN POCKET GLAZE
2.8 & 3.6 METRE LENGTHS

PLEASE NOTE POCKET DIRECTION IF USING AS A DOORFRAME

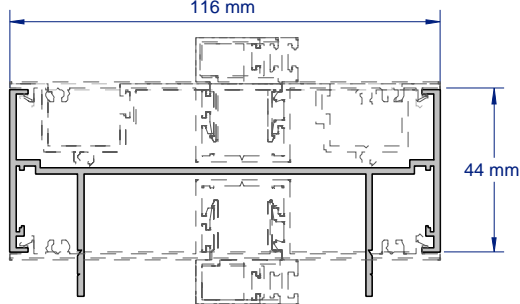

SAP213

45MM CAPPING HEAD / FRAME STARTER
COMPLIES WITH AS1428.1 2009
2.8 & 3.6 METRE LENGTHS

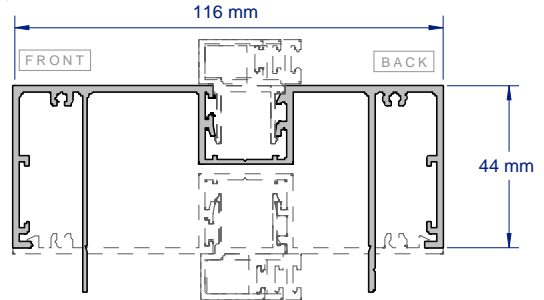

SAP214L

45MM PLASTERBOARD POCKET FRAME
COMPLIES WITH AS1428.1 2009
2.8 & 3.6 METRE LENGTHS

PLEASE NOTE POCKET DIRECTION IF USING AS A DOORFRAME

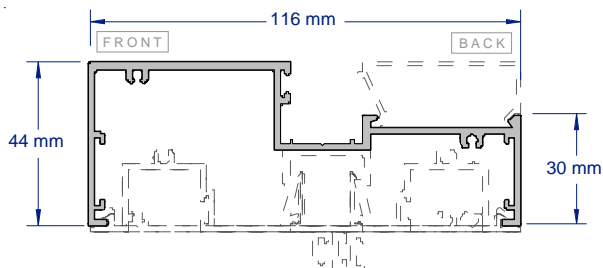

SAP219L

45MM SILL/TRANSOM
2.8 & 3.6 METRE LENGTHS

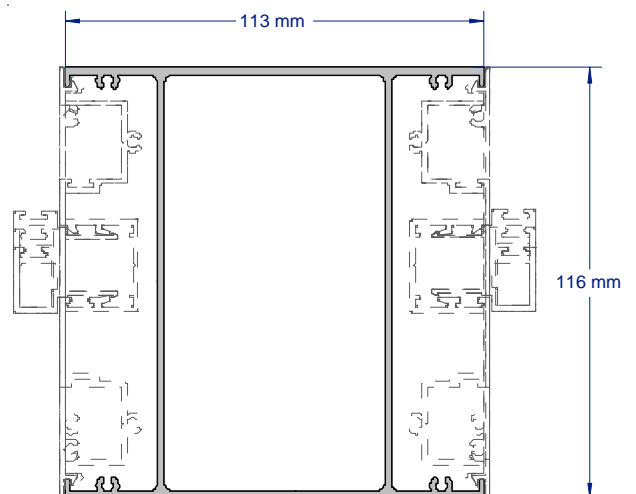

SAP224D

2 WAY POST
COMPLIES WITH AS1428.1 2009
2.8 & 3.6 METRE LENGTHS

ISSUE NO 19.9
DATE : 01/09/2019
REPLACES : 01/10/2018
SUBJECT TO CHANGE WITHOUT NOTICE

SAPPHIRE

BESPOKE SOLUTIONS FOR ALUMINIUM

76 MM MAXLINE® GEN 2

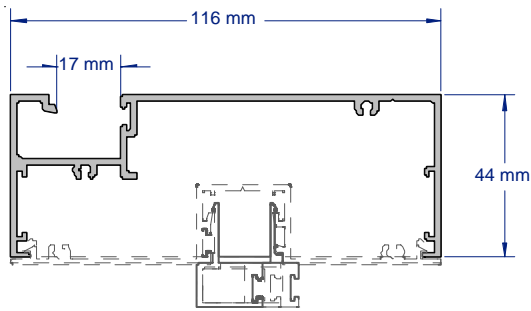

SAP237
FRONT GLAZE FRAME / MULLION
COMPLIES WITH AS1428.1 2009
2.8 & 3.6 METRE LENGTHS

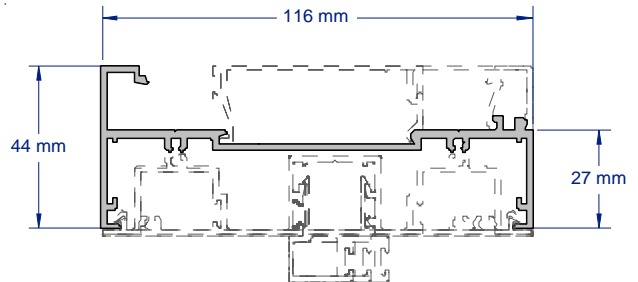

SAP240
DOUBLE GLAZE SILL / MULLION / TRANSOM
COMPLIES WITH AS1428.1 2009
2.8 & 3.6 METRE LENGTHS

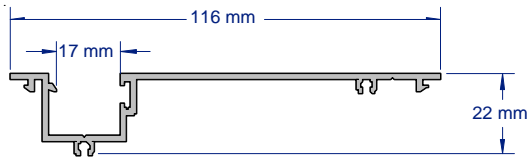

SAP238
FRONT GLAZE SNAPIN
2.8 & 3.6 METRE LENGTHS

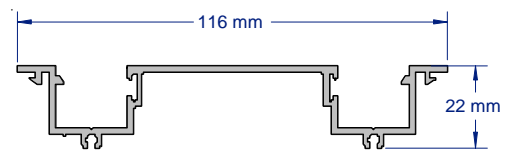

SAP241
DOUBLE GLAZE SNAPIN
2.8 & 3.6 METRE LENGTHS

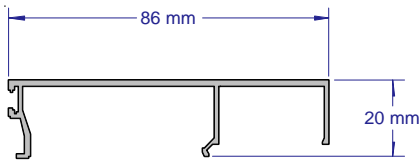

SAP239
FRONT GLAZE SILL BEAD
2.8 & 3.6 METRE LENGTHS

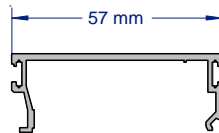

SAP243
DOUBLE GLAZE CAP
2.8 & 3.6 METRE LENGTHS

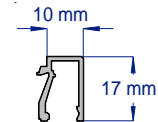

SAP105
GLAZING BEAD
2.8 & 3.6 METRE LENGTHS

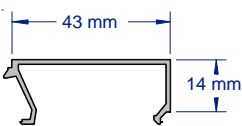

SAP022
SILL/TRANSOM BEAD
2.8 & 3.6 METRE LENGTHS

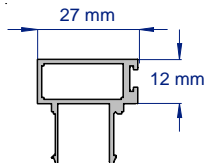

SAPDS35
35MM DOORSTOP (NEW)

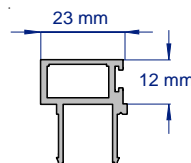

SAPDS40
40MM DOORSTOP (NEW)

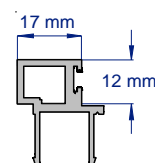

SAPDS45
45MM DOORSTOP (NEW)

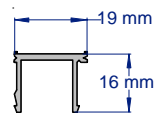

SAPPFI
POCKET FLUSH INFIL (NEW)

PLEASE NOTE! DOOR STOP THICKNESS STATED ALLOWS FOR FLUSH WITH THE EDGE OF THE FRAME WHEN DOOR IS HUNG.
FRAME MUST BE INSTALLED AS SHOWN AS DOORSTOP ONLY SNAPS IN ONE WAY!
AVAILABLE IN 2.8 & 3.6 METRE LENGTHS

ISSUE NO 21.3

DATE : 01/03/2021

REPLACES : 01/09/2020

SUBJECT TO CHANGE WITHOUT NOTICE

SAPPHIRE

BESPOKE SOLUTIONS FOR ALUMINIUM

92MM MAXLINE® GEN 1

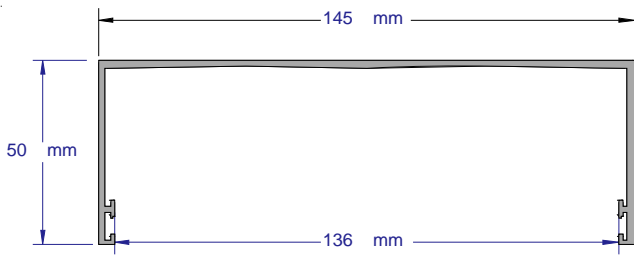

SAP3SH
92MM MAXLINE SUB HEAD - DEFLECTION
2.8 & 3.6 METRE LENGTHS

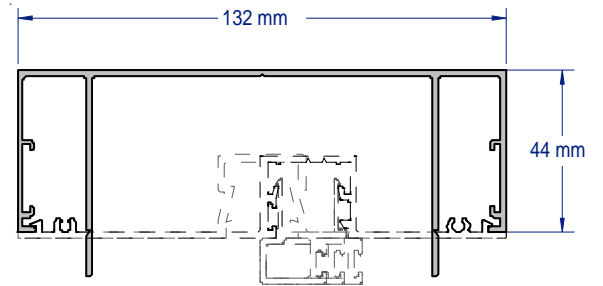

SAP310L
45MM CAPPING HEAD / FRAME
COMPLIES WITH AS1428.1 2009
2.8 & 3.6 METRE LENGTHS

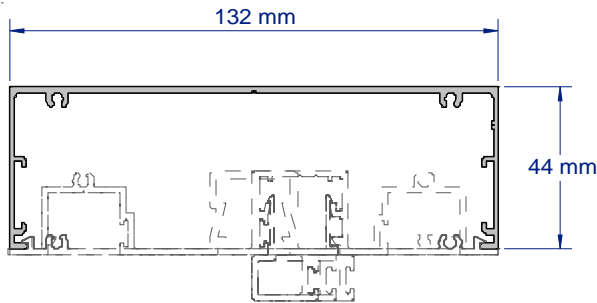

SAP312L
45MM CAPPING / WALLSTARTER
COMPLIES WITH AS1428.1 2009
2.8 & 3.6 METRE LENGTHS



SAP311
SNAP IN FLUSH ADAPTOR
2.8 & 3.6 METRE LENGTHS

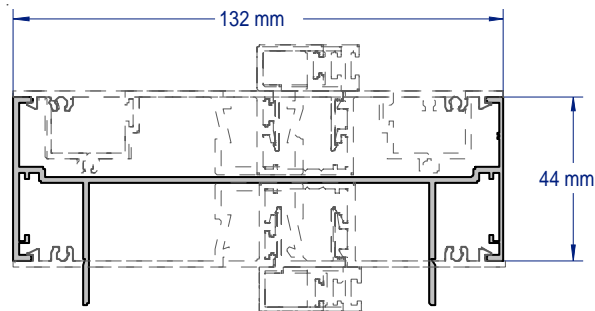

SAP313
45MM MULTI-CAP
COMPLIES WITH AS1428.1 2009
2.8 & 3.6 METRE LENGTHS

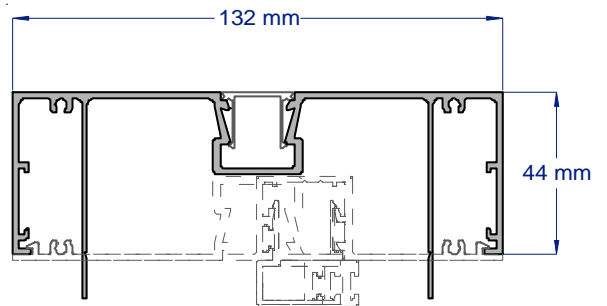

SAP314L
45MM PLASTERBOARD POCKET FIN FRAME
COMPLIES WITH AS1428.1 2009
2.8 & 3.6 METRE LENGTHS

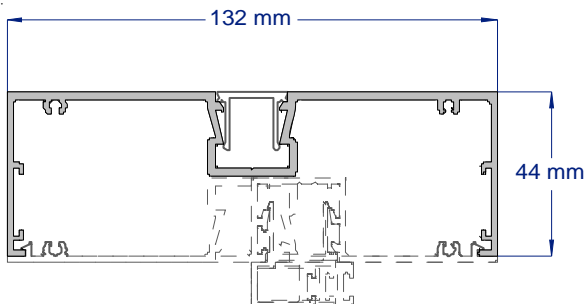

SAP315
45MM PLASTERBOARD POCKET FRAME
COMPLIES WITH AS1428.1 2009
2.8 & 3.6 METRE LENGTHS

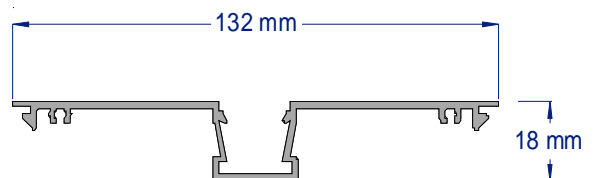

SAP316
SNAP IN POCKET GLAZE
2.8 & 3.6 METRE LENGTHS

ISSUE NO 19.9

DATE : 01/09/2019
REPLACES : 01/10/2018
SUBJECT TO CHANGE WITHOUT NOTICE

SAPPHIRE

BESPOKE SOLUTIONS FOR ALUMINIUM

92MM MAXLINE® GEN 1

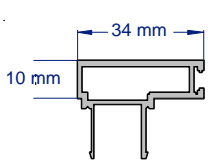

SAP317
35MM DOORSTOP
2.8 & 3.6 METRE LENGTHS

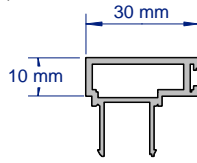

SAP318B
40MM DOORSTOP
2.8 & 3.6 METRE LENGTHS

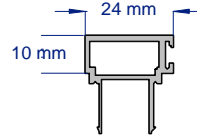

SAP318
45MM DOORSTOP
2.8 & 3.6 METRE LENGTHS

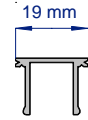

SAP023
POCKET INFIL
2.8 & 3.6 METRE LENGTHS

PLEASE NOTE! DOOR STOP THICKNESS STATED ALLOWS FOR A 5MM SETBACK FROM THE EDGE OF THE FRAME WHEN DOOR IS HUNG

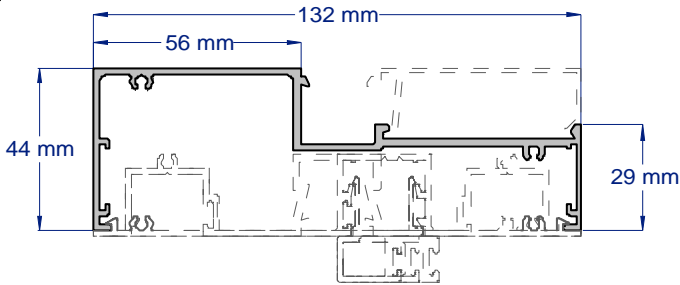

SAP319L
45MM SILL/TRANSOM
COMPLIES WITH AS1428.1 2009
2.8 & 3.6 METRE LENGTHS

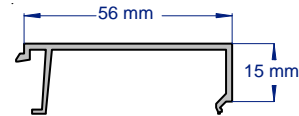

SAP320L
45MM SILL BEAD
2.8 & 3.6 METRE LENGTHS

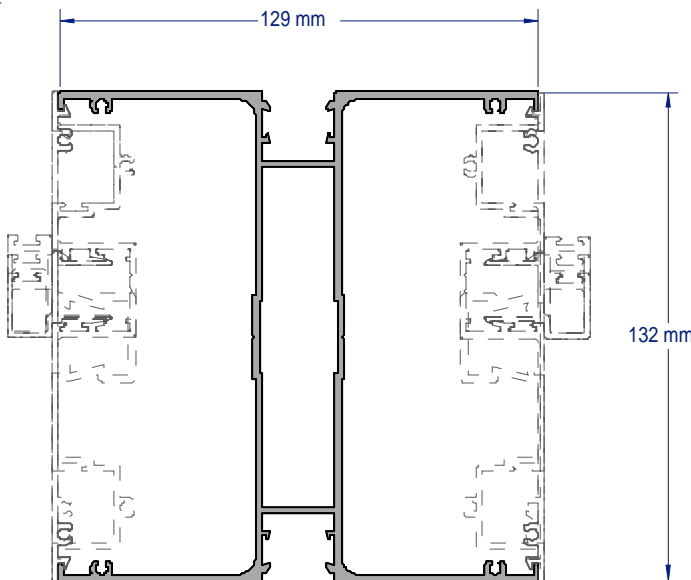

SAP324
132MM 4 WAY POST
COMPLIES WITH AS1428.1 2009
2.8 & 3.6 METRE LENGTHS

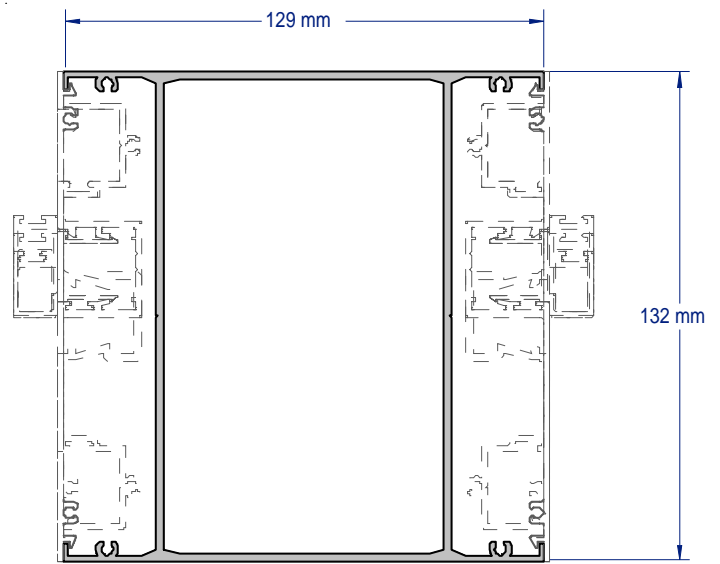

SAP324D
132MM 2 WAY POST
COMPLIES WITH AS1428.1 2009
2.8 & 3.6 METRE LENGTHS

ISSUE NO 21.3

DATE : 01/03/2021

REPLACES : 01/09/2020

SUBJECT TO CHANGE WITHOUT NOTICE

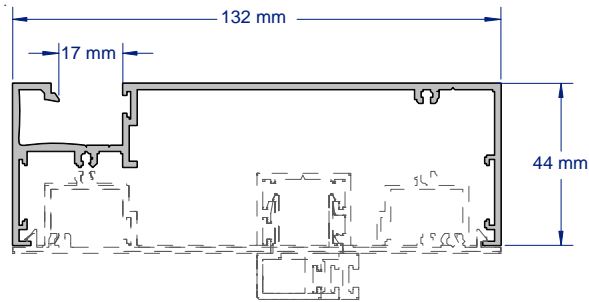

SAP337
 FRONT GLAZE FRAME / MULLION
 COMPLIES WITH AS1428.1 2009
 2.8 & 3.6 METRE LENGTHS

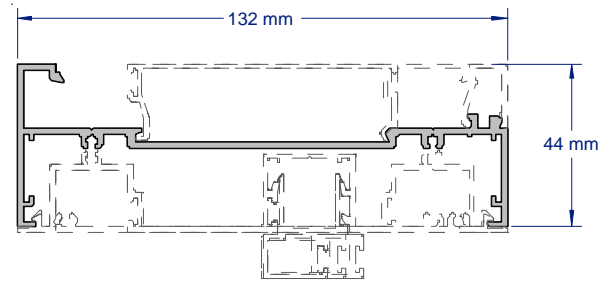

SAP340
 FRONT & DOUBLE GLAZE SILL / MULLION / TRANSOM
 COMPLIES WITH AS1428.1 2009
 2.8 & 3.6 METRE LENGTHS

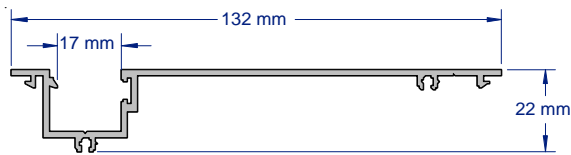

SAP338
 FRONT GLAZE SNAPIN
 2.8 & 3.6 METRE LENGTHS

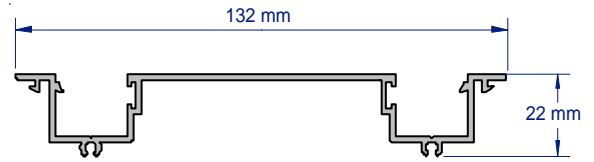

SAP341
 DOUBLE GLAZE SNAPIN
 2.8 & 3.6 METRE LENGTHS

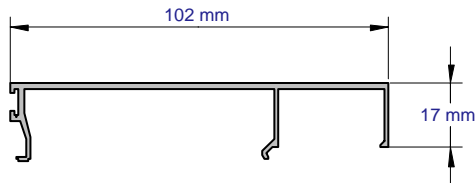

SAP339
 FRONT GLAZE SILL BEAD
 2.8 & 3.6 METRE LENGTHS

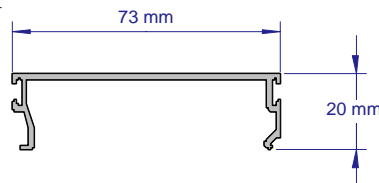

SAP343
 DOUBLE GLAZE CAP
 2.8 & 3.6 METRE LENGTHS

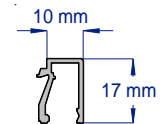

SAP105
 GLAZING BEAD
 2.8 & 3.6 METRE LENGTHS

SAPPHIRE

BESPOKE SOLUTIONS FOR ALUMINIUM

SHOOSHLINE DOOR

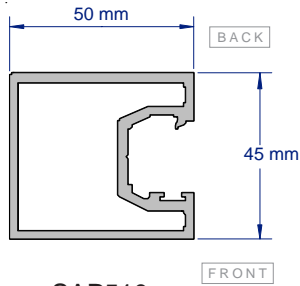

SAP510
50MM PLAIN STILE
2.8 & 3.6 METRE LENGTHS

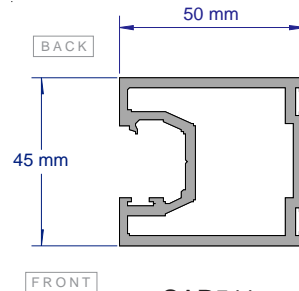

SAP511
50MM CLOSING STILE
2.8 & 3.6 METRE LENGTHS

PLEASE NOTE THAT THESE STILES DO NOT ACCOMODATE MORTICE LOCKS UNLESS COMBINED WITH A MIDRAIL OR BACK PLATE

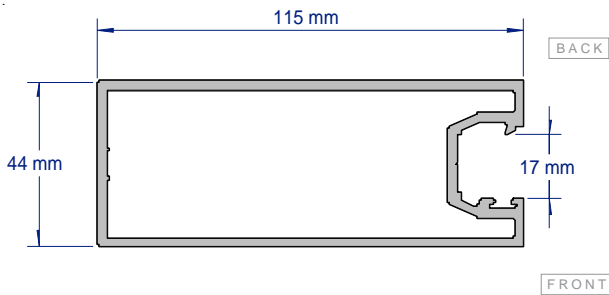

SAP519
115MM WIDE PLAIN STILE (LOCK/HINGE)
2.8 & 3.6 METRE LENGTHS

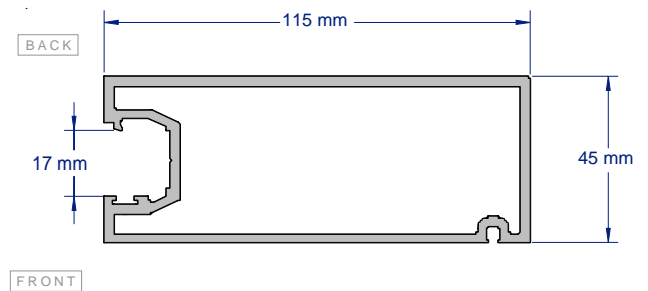

SAP520
115MM WIDE SLIDER STILE
2.8 & 3.6 METRE LENGTHS

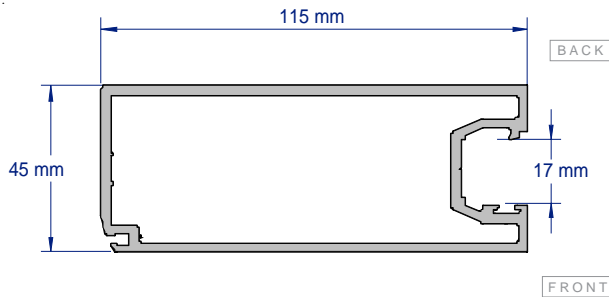

SAP521
115MM WIDE LOCK STILE
2.8 & 3.6 METRE LENGTHS

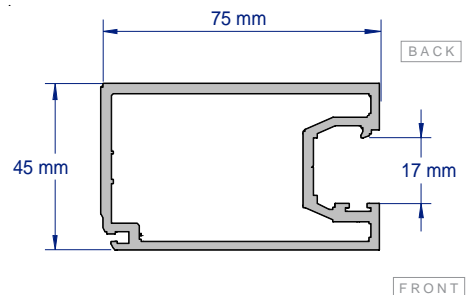

SAP522
75MM LOCK STILE
2.8 & 3.6 METRE LENGTHS

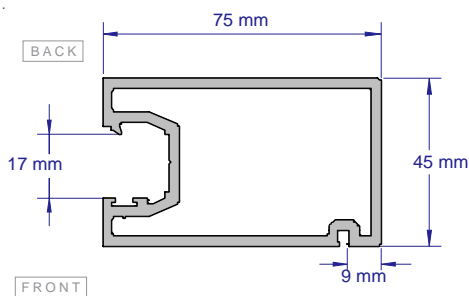

SAP523
75MM SLIDE STILE
2.8 & 3.6 METRE LENGTHS

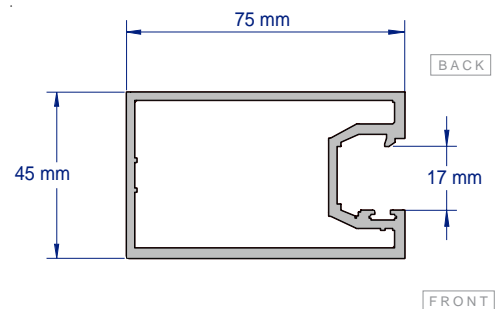

SAP524
75MM PLAIN STILE (LOCK/HINGE)
2.8 & 3.6 METRE LENGTHS

ISSUE NO 21.3

DATE : 01/03/2021

REPLACES : 01/09/2020

SUBJECT TO CHANGE WITHOUT NOTICE

SAPPHIRE

BESPOKE SOLUTIONS FOR ALUMINIUM

SHOOSHLINE DOOR

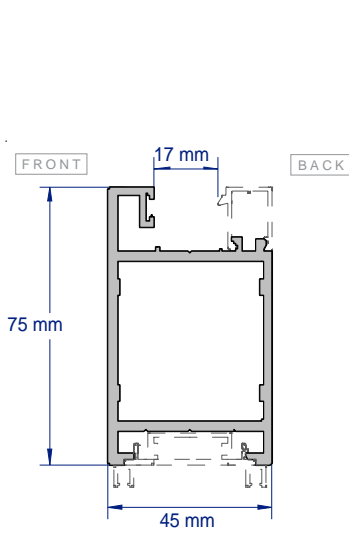

SAP525
75MM TOP/BOTTOM RAIL
2.5 & 3.6 METRE LENGTHS

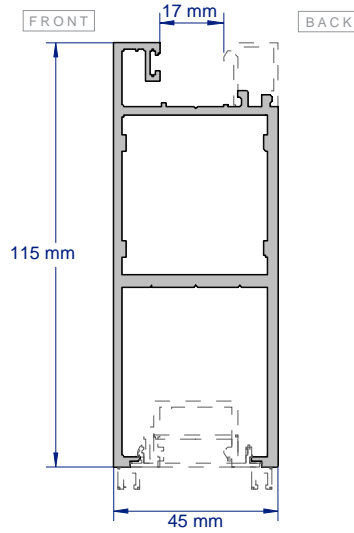

SAP526
115MM TOP/BOTTOM/MID RAIL
2.5 & 3.6 METRE LENGTHS

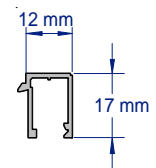

SAP528
CLIP IN RAIL BEAD
2.5 & 3.6 METRE LENGTHS

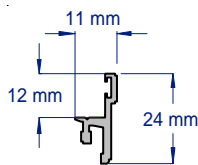

SAP429
MEETING STILE ADAPTOR
6.5 METRE LENGTHS
SUITS SAP521,522

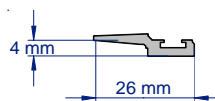

SAP430
INTERLOCK (SMALL)
6.5 METRE LENGTHS

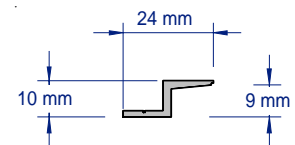

SAP434
INTERLOCK (LARGE)
6.5 METRE LENGTHS

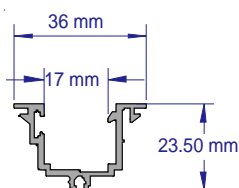

SAP116
MIDRAIL ADAPTOR FOR SAP526
2.8 & 3.6 METRE LENGTHS

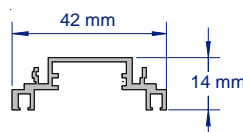

SAP535
CLIPIN BOTTOM SEAL ROLLER GUIDE FOR SAP525/526
3.6 METRE LENGTHS
(TOP BE NOTCHED WITH SAW WHERE SCREWS FOR SPIGGOT ARE LOCATED WHEN USING WITH SAP525)

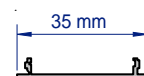

SAP111
FLAT SNAPIN
2.8 & 3.6 METRE LENGTHS

ISSUE NO 19.9
DATE : 01/09/2019
REPLACES : 01/10/2018
SUBJECT TO CHANGE WITHOUT NOTICE

SAPPHIRE

BESPOKE SOLUTIONS FOR ALUMINIUM

SHOOSHLINE DOOR

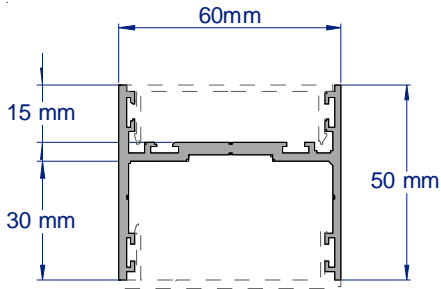

SAP582
50MM OVERHEAD/CLOSING CHANNEL
2.8, 3.6 & 5.6 METRE LENGTHS

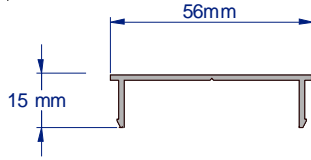

SAP583
CLOSING CHANNEL COVER - INNER
2.8 & 3.6 METRE LENGTHS

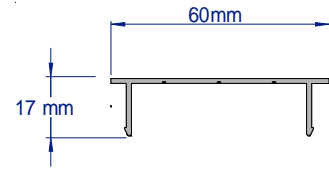

SAP583-O
CLOSING CHANNEL COVER - OUTER
2.8 & 3.6 METRE LENGTHS

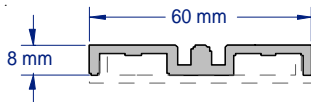

SAP484
FLOOR TRACK - TOP
3.6 & 5.6 METRE LENGTHS

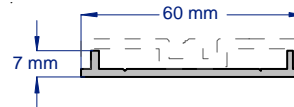

SAP484/B
FLOOR TRACK - BASE
3.6 & 5.6 METRE LENGTHS

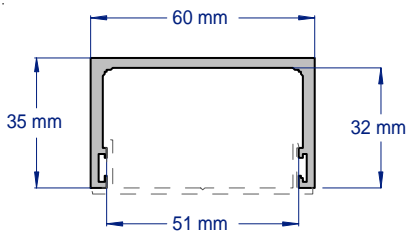

SAP487
35MM OVERHEAD CHANNEL
6.5 METRE LENGTHS

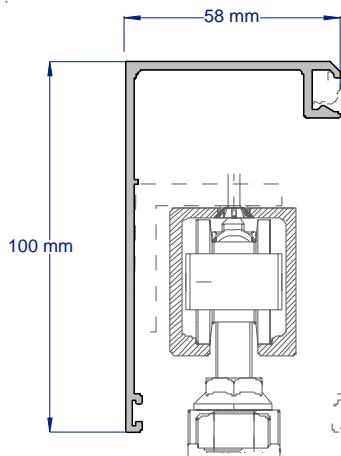

SAP585
SHOOSHLINE OVERHEAD PELMET
3.6 METRE LENGTHS
(DOOR TRACK & FIXING ANGLE SOLD SEPERATELY)

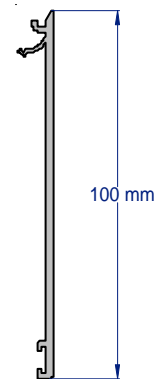

SAP586
SHOOSHLINE OVERHEAD PELMET COVER
3.6 METRE LENGTHS

ISSUE NO 21.3

DATE : 01/03/2021

REPLACES : 01/09/2020

SUBJECT TO CHANGE WITHOUT NOTICE

SAPPHIRE

BESPOKE SOLUTIONS FOR ALUMINIUM

SKIRTING & TRIMS

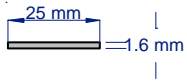

SAS25X1.6
25MM TRIM/SKIRTING
3.6 METRE LENGTHS

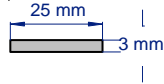

SAS25X3
25MM TRIM/SKIRTING
3.6 METRE LENGTHS

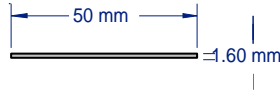

SAS50X1.6
50MM X 1.6MM FLATBAR/SKIRTING
3.6 METRE LENGTHS

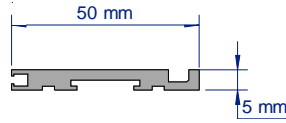

SAP50X5SK
50MM X 5MM REBATE SKIRTING
3.6 METRE LENGTHS

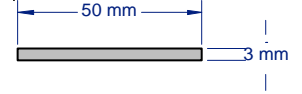

SAS50X3
50MM X 3MM FLATBAR/SKIRTING
3.6 METRE LENGTHS

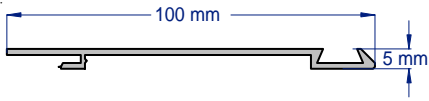

SAP009
100MM SCREWFIX SKIRTING
3.6 METRE LENGTHS

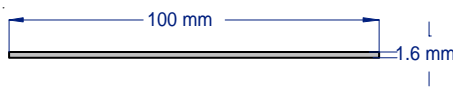

SAS100X1.6
100MM X 1.6MM FLATBAR/SKIRTING
3.6 METRE LENGTHS

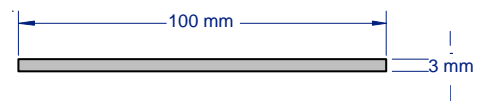

SAS100X3
100MM X 3MM FLATBAR/SKIRTING
3.6 METRE LENGTHS

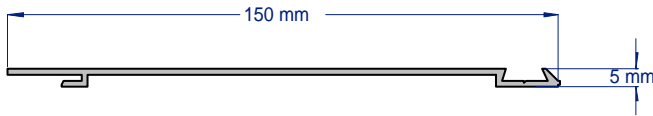

SAP009/B
150MM SCREWFIX SKIRTING
3.6 METRE LENGTHS

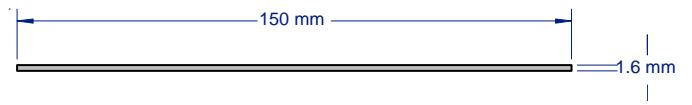

SAS150X1.6
EXTRUDED 150MM X 1.6MM FLATBAR/SKIRTING
3.6 METRE LENGTHS

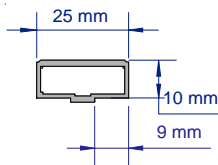

SAP25T
25MM STICK ON MULLION / TRANSOM TRIM
2.8 & 3.6 METRE LENGTHS

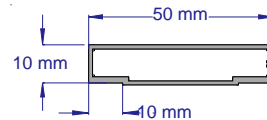

SAP50T
50MM STICK ON MULLION / TRANSOM TRIM
2.8 & 3.6 METRE LENGTHS

ISSUE NO 19.9

DATE : 01/09/2019

REPLACES : 01/10/2018

SUBJECT TO CHANGE WITHOUT NOTICE

PLEASE NOTE: ALL OUR WIDELINE AND 76MM MAXLINE SECTIONS HAVE DIRECTIONAL POCKETS FEATURING SLIDE IN WEDGE. THIS MEANS THAT THE DOORSTOP CAN ONLY SNAP IN ONE WAY.

PLEASE ENSURE YOU INSTALL THE DOORFRAME CORRECTLY TO ENSURE THE DOORSTOP WILL CLIP IN FOR DIRECTION YOU WISH TO SWING THE DOOR. FOR INWARDS OPENING DOORS THE SLIDE IN WEDGE POCKET SHOULD BE AT THE FRONT OR CORRIDOR SIDE.

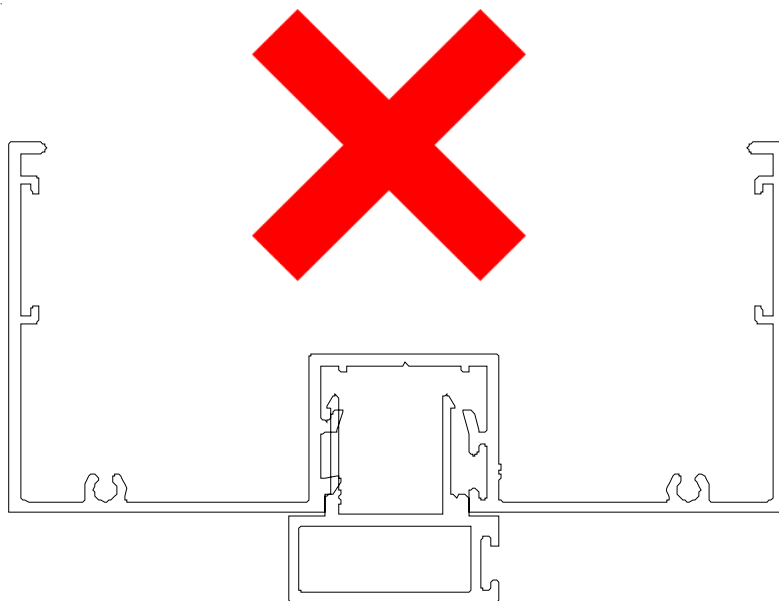
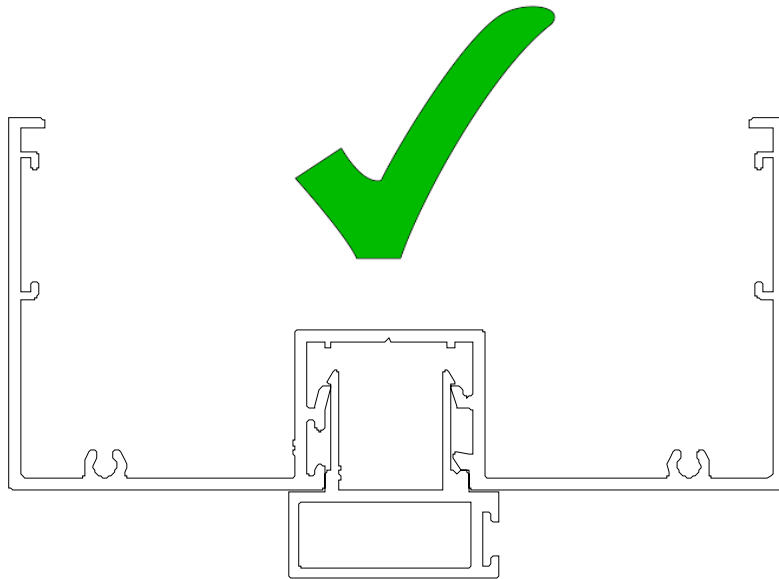

NOTE ABOVE IS INCORRECT AND WILL NOT ALLOW THE DOORSTOP TO CLIP IN

Use the following wedge and glass options for
**Microline, Wideline Gen 3, Frontline Gen 2, 76mm Maxline Gen 2, 92mm Maxline Front /
 Double Glaze and Shooshline Doors**

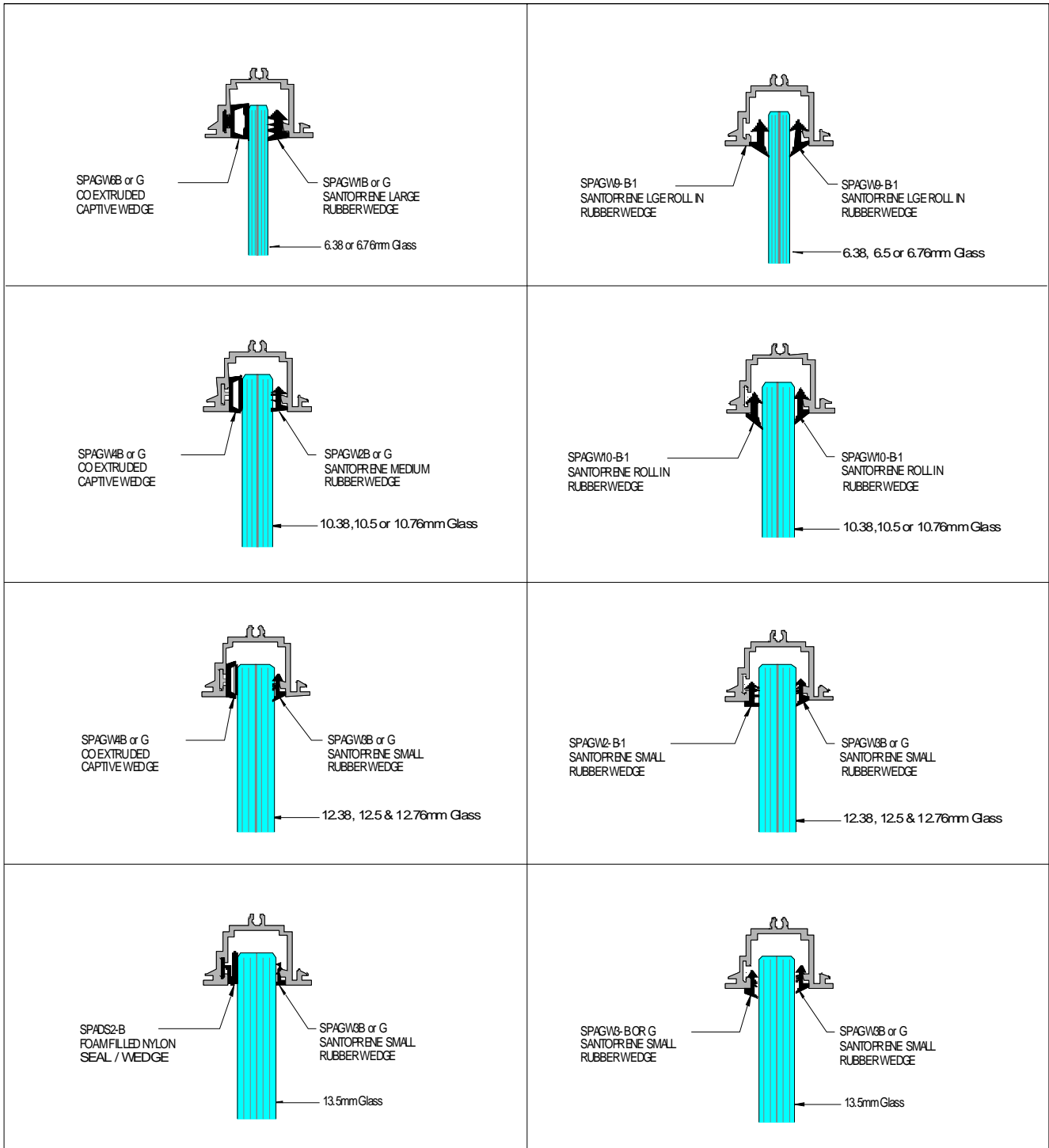

SLIDE IN CO-EX CAPTIVE OPTION

PUSH IN WEDGE OPTION

ISSUE NO 19.9

DATE : 01/09/2019

REPLACES : 01/10/2018

SUBJECT TO CHANGE WITHOUT NOTICE

Use the following wedge and glass options for **left side**
Wideline Gen 2, 92mm Maxline Gen 1 Centre Glaze
 Use the following wedge and glass options for **right side**
Sapphire 400 Entry Doors

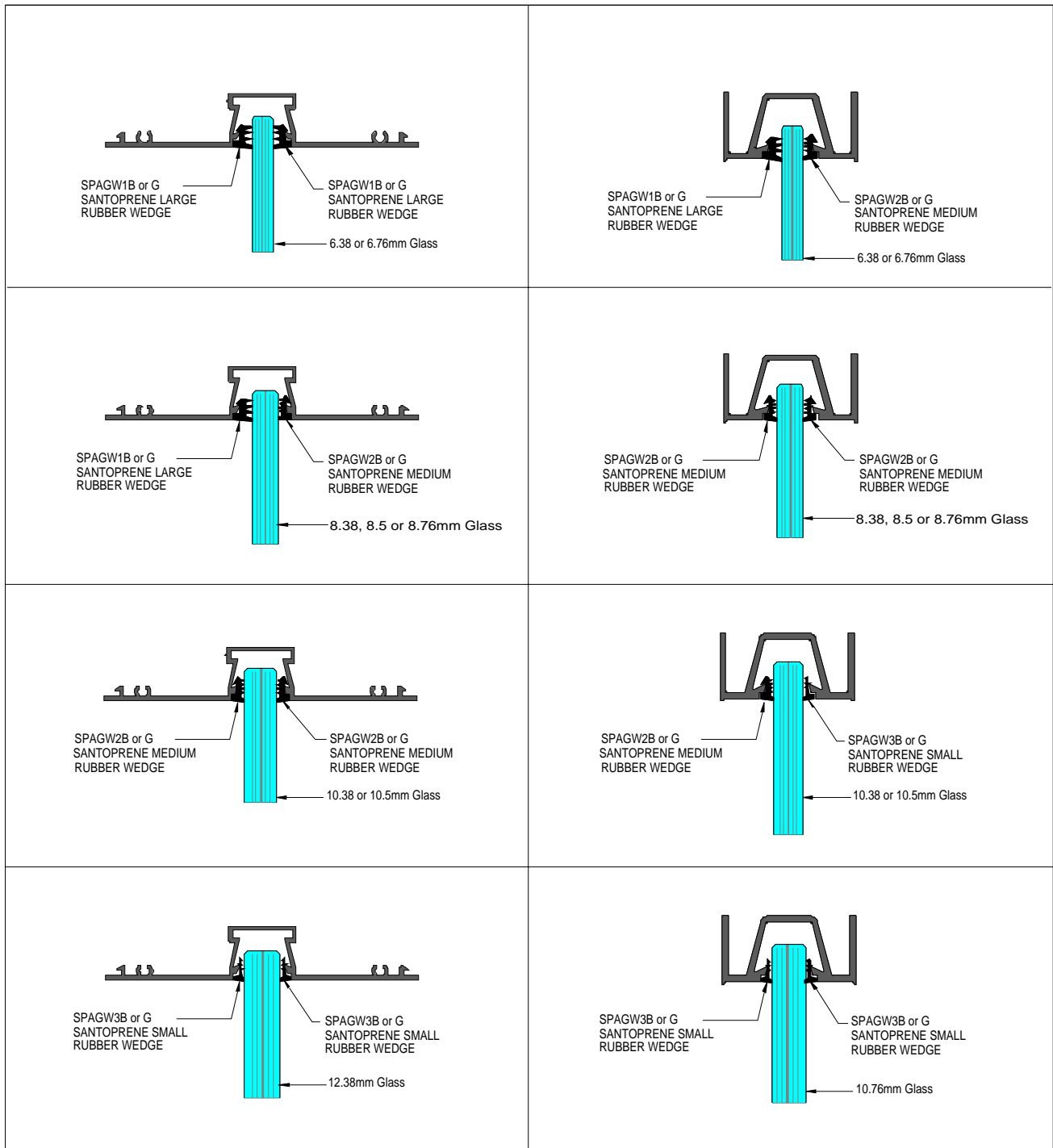

Use the following tape and glass options for **Microline, Wideline Gen 3, Frontline Gen 2, 76mm Maxline Gen 2, 92mm Maxline Front / Double Glaze.**

Use the following tape and glass options for **Shooshline Doors**

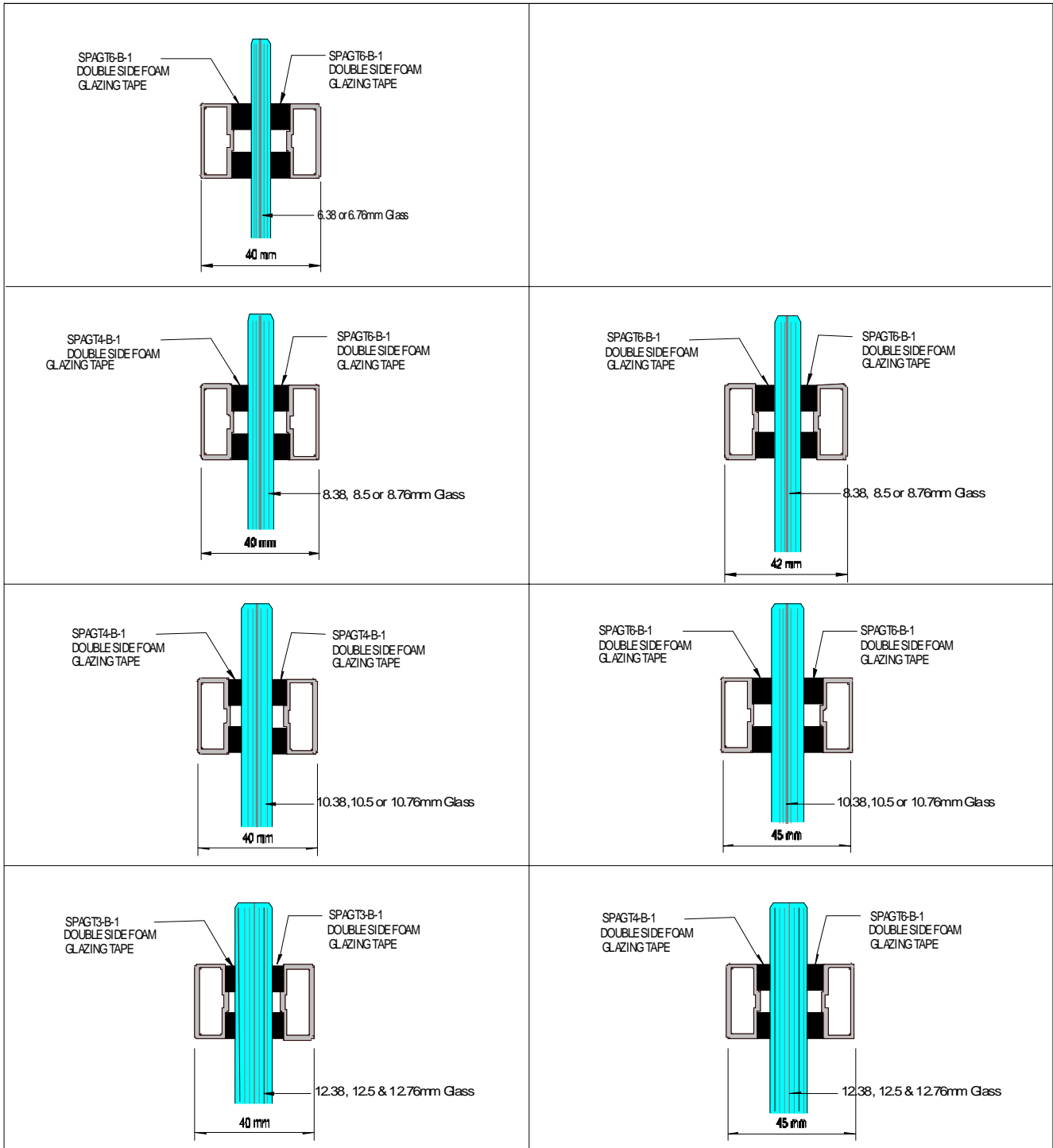

PLEASE NOTE OPTIONS ABOVE APPLY TO SAP50T AS WELL

ISSUE NO 19.9

DATE : 01/09/2019

REPLACES : 01/10/2018

SUBJECT TO CHANGE WITHOUT NOTICE

SAPPHIRE

BESPOKE SOLUTIONS FOR ALUMINIUM

ACCESSORIES

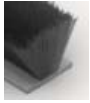

SPADS1-B or G
MOHAIR SEAL 6.5mm H
BLACK OR GREY
100 METRE ROLLS

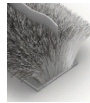

SPADS1F-B
MOHAIR FIN SEAL 6.5mm H
BLACK ONLY
350 METRE ROLLS



SPADS2-B
NYLON FOAM FILLED ACOUSTIC SEAL/WEDGE
BLACK ONLY
305 METRE ROLLS OR BY THE METRE



SPADS3-B or G
PVC BULB SEAL 6MM HIGH
BLACK or GREY
100 METRE ROLLS OR BY THE METRE



SPADS4-B or G
SANTOPRENE ACOUSTIC BULB SEAL
BLACK OR GREY
100 METRE ROLLS
USE WITH SAP046



SPADS5-B
CO-EX BULB SEAL - 8MM H
BLACK ONLY
100 METRE ROLLS OR BY THE METRE
USE WITH SAP108 - 40MM DOORS



SPADS6-B
NYLON FOAM FILLED BULB SEAL - 6.5MM H
BLACK ONLY
500 METRE ROLLS OR BY THE METRE



SPASKC-B or G
SKIRTING INFIL COVER
BLACK OR GREY
100 METRE ROLLS



SPAGW1-B or G
SANTOPRENE GLAZING WEDGE - Large
BLACK OR GREY
100 METRE ROLLS



SPAGW2-B or G
SANTOPRENE GLAZING WEDGE - Medium
BLACK OR GREY
100 METRE ROLLS



SPAGW3-B or G
SANTOPRENE GLAZING WEDGE - Small
BLACK OR GREY
100 METRE ROLLS



SPAGW4-B or G
CAPTIVE CO-EX DOORSEAL / GLAZING WEDGE
10MM - 12.76MM
BLACK
100 METRE ROLLS
INSERT BEFORE FABRICATION



SPAGW6-B or G
CAPTIVE CO-EX DOORSEAL / GLAZING
WEDGE - 6.38MM
BLACK
100 METRE ROLLS
INSERT BEFORE FABRICATION



SPAGW9-B
ROLL IN GLAZING WEDGE - 6.38MM
BLACK
100 METRE ROLLS
ALT OPTION FOR SPAGW6-B-1



SPAGW10-B
ROLL IN GLAZING WEDGE - 10.38 - 12.50MM
BLACK
100 METRE ROLLS
ALT OPTION FOR SPAGW4-B-1

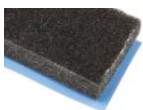

SPAGT1-B-1
Double Sided Black Foam Glazing Tape
9.0MM (W) X 1.6MM (H)
BLACK 45.7 METRE ROLLS

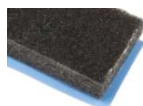

SPAGT3-B-1
Double Sided Black Foam Glazing Tape
9.0MM (W) X 3.2MM (H)
BLACK 22.85 METRE ROLLS

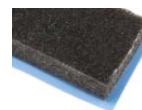

SPAGT4-B-1
Double Sided Black Foam Glazing Tape
9.0MM (W) X 4.8MM (H)
BLACK 15.2 METRE ROLLS

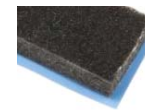

SPAGT6-B-1
Double Sided Black Foam Glazing Tape
9.0MM (W) X 6.4MM (H)
BLACK 15.2 METRE ROLLS

ISSUE NO 21.3

DATE : 01/03/2021

REPLACES : 01/09/2020

SUBJECT TO CHANGE WITHOUT NOTICE

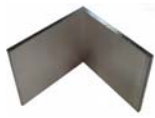

SPACS1-M-1
MICROLINE DOORJAMB CORNER STAKE
60MM X 60MM X 55MM
BAGS OF 50



SPACS3-M-1
ZINC PRE DRILL CORNER STAKE - VERT 90
50MM X 50MM X 15MM
BAGS OF 100



SPACS5 B or G
SKIRTING CORNER/END STAKE
TO SUIT 100MM - 150MM SCREWFIX
BAGS OF 50



SPACS7-M-1
CRINKLED CORNER STAKE
80MM X 17.5MM
BAGS OF 50



SPACS6-M-1
CRINKLED CORNER STAKE - VERT 90
60MM X 60MM X 17.5MM
BAGS OF 50



SPACS8-M-1
CRINKLED CORNER STAKE - HORIZONTAL
60MM X 60MM X 17.5MM
BAGS OF 50

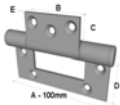

SPAHG168
ALUMINIUM TAPERLEAF
FASTFIX HINGE
100MM X 50MM EACH

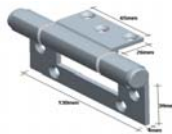

SPAHG105
ALUMINIUM HEAVYDUTY
SINGLE FASTFIX HINGE
130MM X 50MM EACH

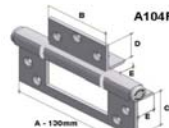

SPAHG104
ALUMINIUM HEAVYDUTY
DOUBLE FASTFIX HINGE
130MM X 50MM EACH



SPASTSC
HALF MOON DOORSTOP
ALSO IN P/COAT AND CHROME
EACH



SSASP-M-1
ALUMINIUM SPIGGOT SET
4 LONG BOLTS



SSATHR-M-1
TOP HUNG ROLLER
PAIRS (SUITS SAP485 ONLY)



SSABTR-M-1
BOTTOM TRACK ROLLERS
EACH (150KG LOAD - SUITS SAP484)



SSAFGC-M-1
SLIDING DOOR FLOOR GUIDE
EACH (SUITS SAP535)



SSADS12 B or G
MOHAIR SEAL FOR SHOOSHLINE 11MM H
BLACK OR GREY
PER MTR



SSADS13 B or G
MOHAIR SEAL FOR SHOOSHLINE 13MM H
BLACK OR GREY
PER MTR



SSADS14 B or G
SLIDING DOOR ACOUSTIC
SANTOPRENE SEAL
100 METRE ROLLS



SSADS16 B
NYLON FOAM FILLED ACOUSTIC SEAL TO
SUIT SAP429
AVAILABLE PER METRE

ISSUE NO 19.9

DATE : 01/09/2019

REPLACES : 01/10/2018

SUBJECT TO CHANGE WITHOUT NOTICE

Australia

NEW SOUTH WALES

Sapphire Aluminium Pty Ltd
MANUFACTURERS FOR AUST & ASIA
19 -29 Pile Road,
Somersby Industrial Estate
SOMERSBY New South Wales 2250

Phone : 61 2 4304 3555
Facsimile : 61 2 4304 3533
email : sapsom@sapal.com.au

VICTORIA

Sapphire Aluminium Pty Ltd
TECHNICAL INFORMATION AND SPECIFICATION
PO Box 7534
Beaumaris Victoria 3193

Phone : 61 3 9589 4222
Facsimile : 61 3 9589 4322
email : sapvic@sapal.com.au

SOUTH AUSTRALIA

Trojan Aluminium Pty Ltd
Cnr Cross Keys Road & CB Fisher Drive
CAVAN South Australia 5094

Phone : 61 8 8260 6055
Facsimile : 61 8 8262 2260
email : trojan@bigpond.net.au

WESTERN AUSTRALIA

Westgyp Pty Ltd
39 Ledger Road
BALCATT Western Australia 6021

Phone : 61 8 9240 5488
Facsimile : 61 8 9240 7433
email : sales@westgyp.com.au

QUEENSLAND

Coming Soon
Refer to Sapphire Somersby

NORTH QUEENSLAND

Coming Soon
Refer to Sapphire Somersby

NORTHERN TERRITORY

Coming Soon
Refer to Sapphire Somersby

TASMANIA

Refer to Sapphire Somersby